

HUSQVARNA TE/ FE MODELS (ENDURO MODELS)

M O U N T I N G I N S T R U C T I O N S

REF 20548

SEMICARENADO RALLY / RALLY SEMIFAIRING

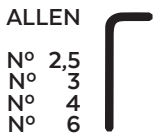

1

DISASSEMBLY
DESMONTAJE

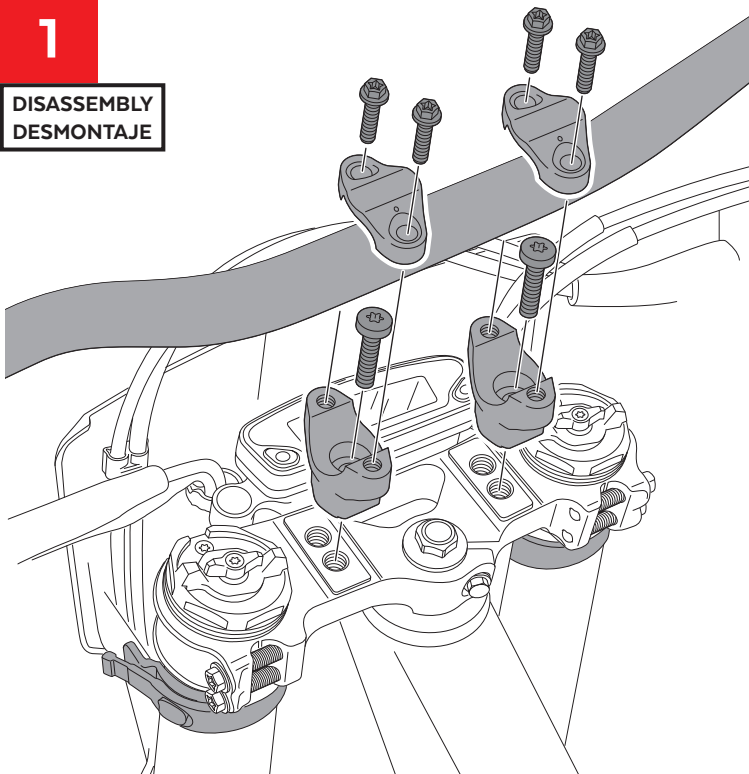

2

DISASSEMBLY
DESMONTAJE

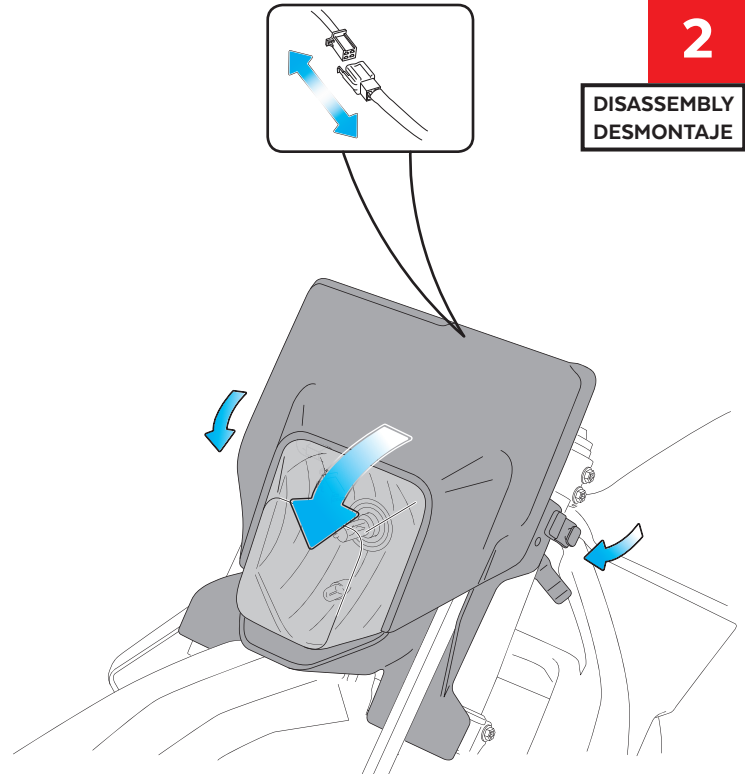

HUSQVARNA TE/ FE MODELS (ENDURO MODELS)

INSTRUCCIONES DE MONTAJE - MOUNTING INSTRUCTIONS - MONTAGEANLEITUNG

3

DISASSEMBLY
DESMONTAJE

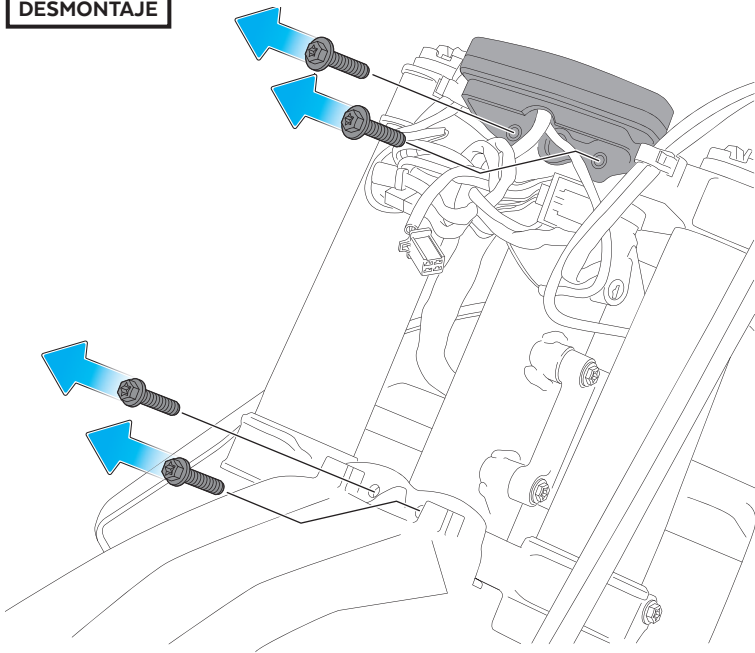

4

ASSEMBLY
MONTAJE

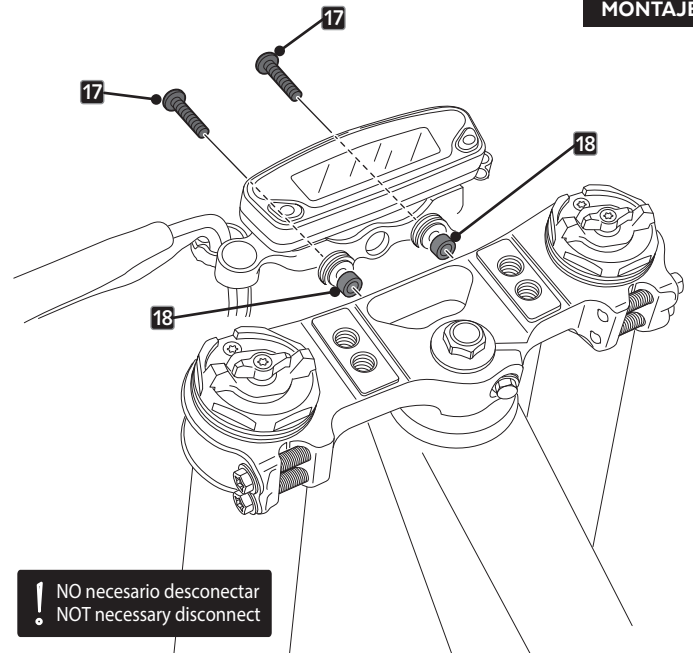

! NO necesario desconectar
! NOT necessary disconnect

5

ASSEMBLY
MONTAJE



Par de apriete - 40 N.m
Tightening torque -40N.m

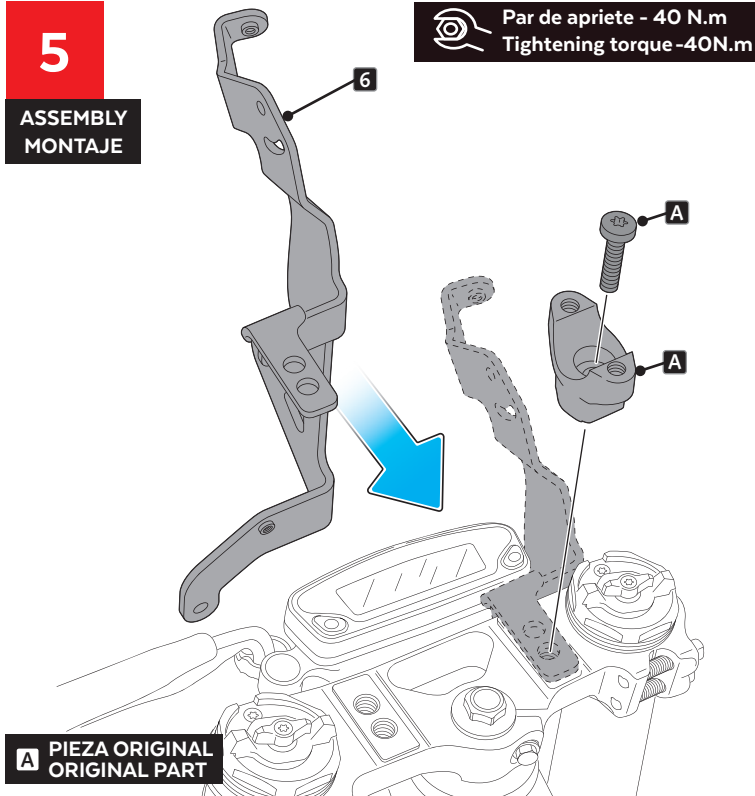

A PIEZA ORIGINAL
ORIGINAL PART

6

ASSEMBLY
MONTAJE



Par de apriete - 40 N.m
Tightening torque -40N.m

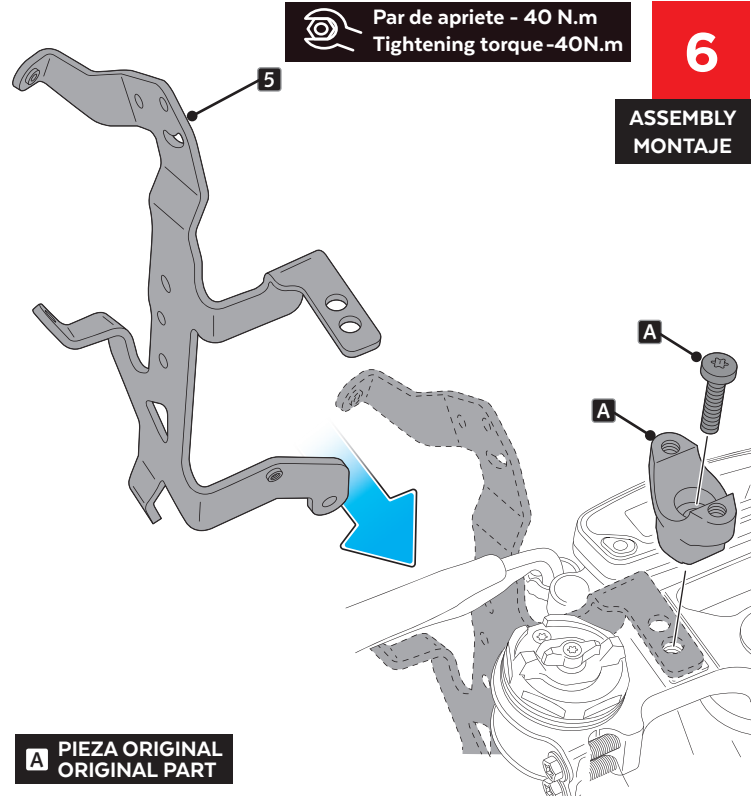

A PIEZA ORIGINAL
ORIGINAL PART

HUSQVARNA TE/ FE MODELS (ENDURO MODELS)

INSTRUCCIONES DE MONTAJE - MOUNTING INSTRUCTIONS - MONTAGEANLEITUNG

7



Par de apriete - 20 N.m
Tightening torque -20N.m

ASSEMBLY
MONTAJE

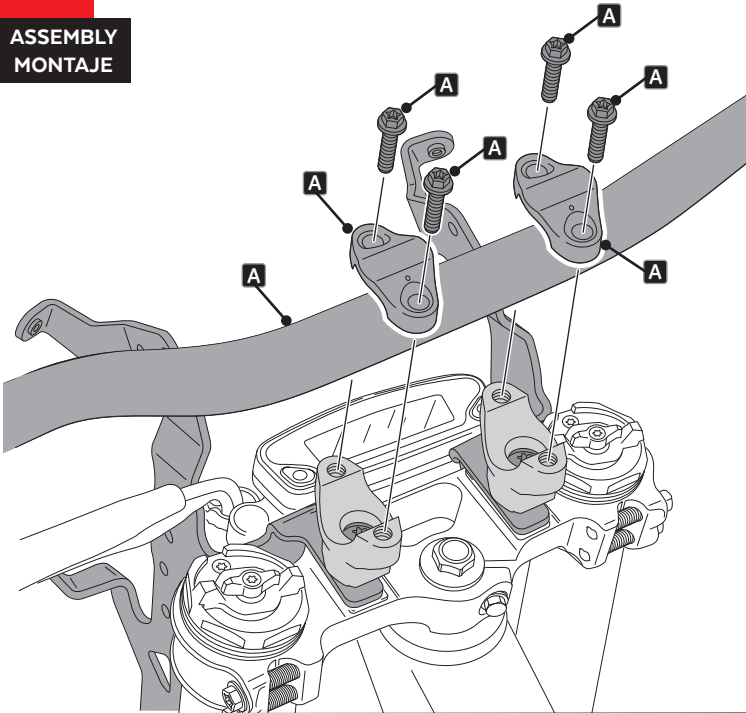

8

! CONNECT ID4

ASSEMBLY
MONTAJE

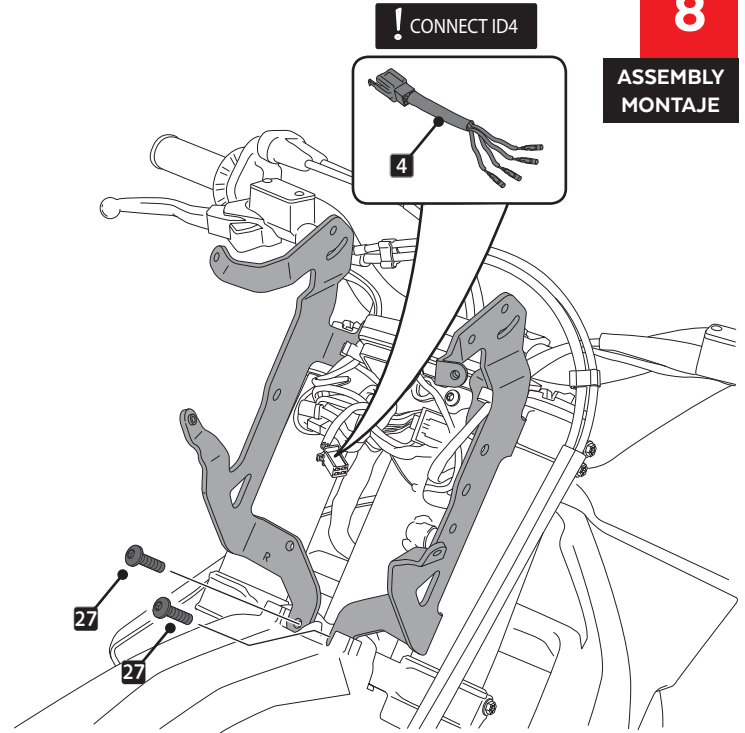

9

ASSEMBLY
MONTAJE

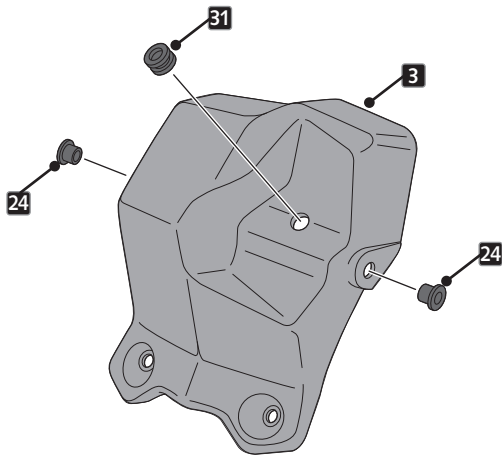

10

ASSEMBLY
MONTAJE

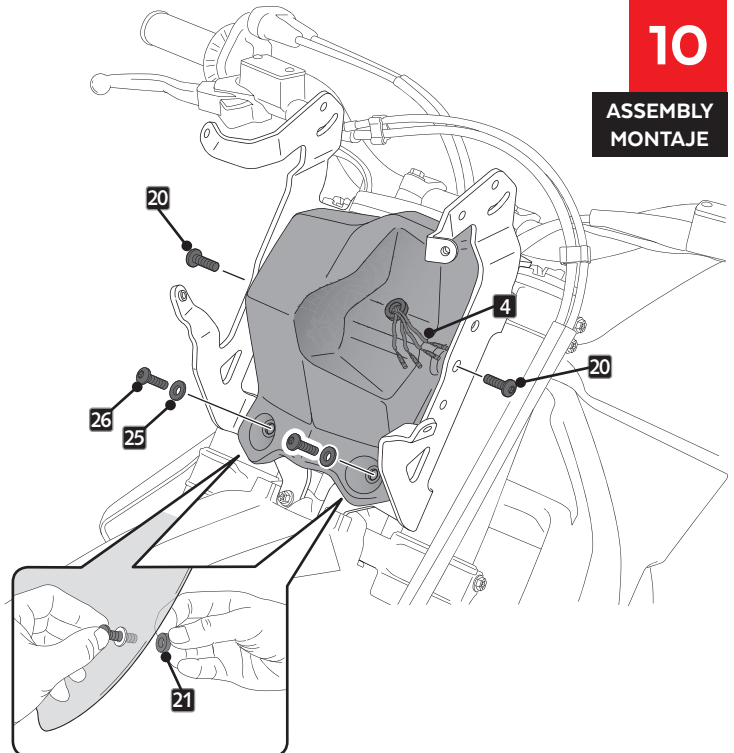



HUSQVARNA TE/ FE MODELS (ENDURO MODELS)

INSTRUCCIONES DE MONTAJE - MOUNTING INSTRUCTIONS - MONTAGEANLEITUNG

11

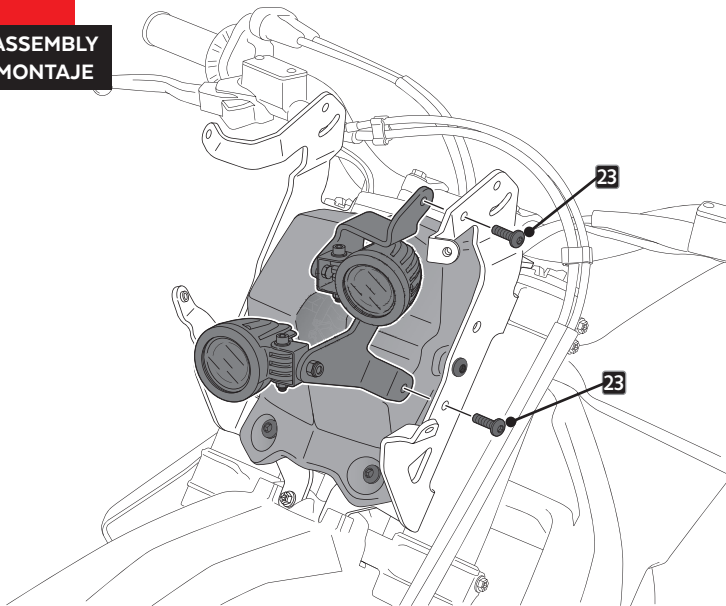
ASSEMBLY
MONTAJE



 Ver pág 5 para conectar ID4
See page 5 to connect ID4

12

ASSEMBLY
MONTAJE

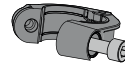

PASAR CABLEADO DE LA MOTO POR LA BRIDA
Y APRETAR TORNILLO ID15
PASS THE MOTORCYCLE WIRING THROUGH THE
BRIDGE AND TIGHTEN THE ID15 SCREW

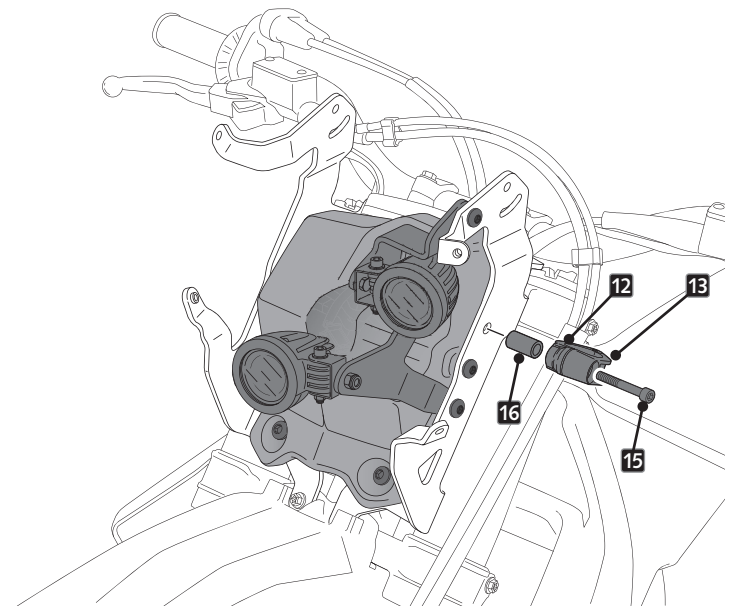

13

ASSEMBLY
MONTAJE

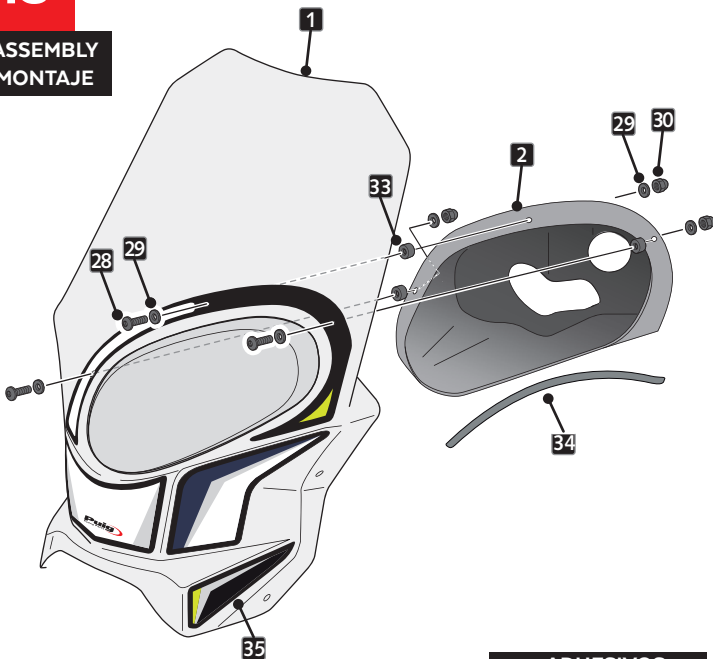





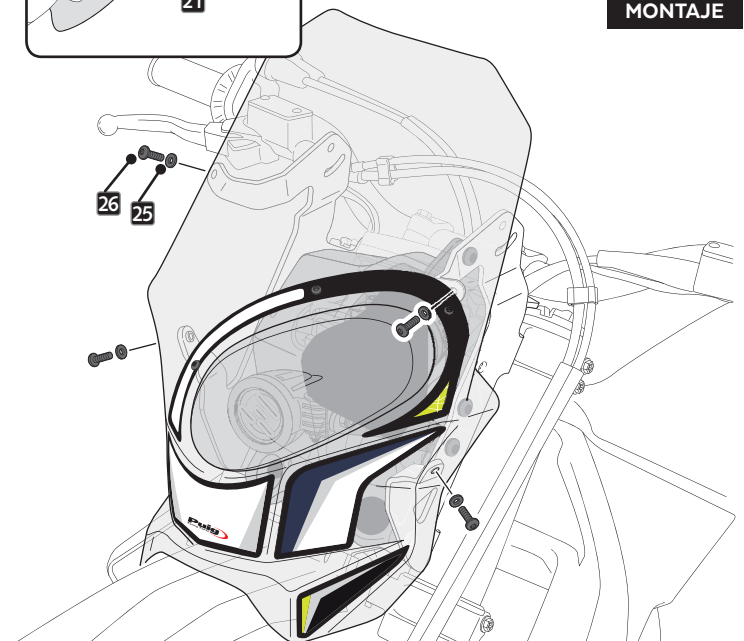
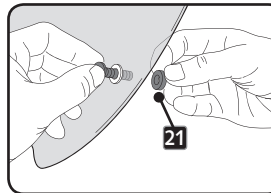

35 ADHESIVOS
STICKERS SET

14



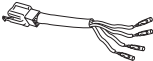
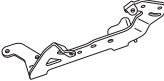
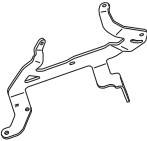

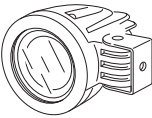

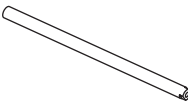

















ASSEMBLY
MONTAJE



HUSQVARNA TE/ FE MODELS (ENDURO MODELS)

ID	PIEZA/PART	DESCRIPCIÓN	DESCRIPTION	QTY	REF
1		Semicarenado Rally (Lexan Policarbonate)	Rally semifairing (Lexan Policarbonate)	1	10809WM3
2		Tapa óptica (ABS)	Optic cover (ABS)	1	10809JM3
3		Tapa posterior (ABS)	Optic back cover (ABS)	1	10809JM3
4		Adaptador cables	Wires adapter	1	10810
5		Soporte de aluminio Izquierdo	Left Aluminium support	1	SOP6P14L--20507
6		Soporte de aluminio Derecho	Right Aluminium support	1	SOP6P14R--20507
7		Soportede aluminio ópticas	Optics Aluminium support	1	SOP6P14O--20507
8		Ópticas led 10W (Homologado CE)	10W Led Optics (CE Homologated)	2	10811N
9		Soporte de aluminio Izquierdo Roadboock	Roadboock Left Aluminium support	1	SOP6P14LR--20507
10		Soporte de aluminio Derecho Roadboock	Roadboock Right Aluminium support	1	SOP6P14RR--20507
11		Varilla de aluminio	Aluminium Guide	1	SOP6P14V---20507

HUSQVARNA TE/ FE MODELS (ENDURO MODELS)

ID	PIEZA/PART	DESCRIPCIÓN	DESCRIPTION	QTY	REF
12		Semi-bridla corta	Short semi-bridle	1	BRIDAANT-0-PR16
13		Semi-bridla larga	Large semi-bridle	1	BRIDAPOS-0-PR16
14		Pasador cilindrico Ø4x20mm	Ø4x20mm cross dowel pin	1	VARILI4X20--576
15		Tornillo M8x50 DIN912	M8x50 DIN912 screw	1	TORNI-D912--532
16		Casquillo Ø14x Ø8,5 x22	Ø14x Ø8,5 x22 arrowhead	1	CASQUI-----150
17		Tornillo M6x40 DIN912	M6x40 DIN912 screw	2	TORNIAD912-0058
		Tornillo M6x30 DIN912	M6x30 DIN912 screw	2	TORNI-D912--725
18		Casquillo Ø8 x Ø14x15mm	Ø8 x Ø14x15mm arrowhead	2	CASQUI181415-101
19		Arandela Grower DIN127 M6 (negro)	DIN127 M6 grower washer (black)	2	ARAND-D127--528
20		Tornillo Allen M5x16 Ø11 ISO 7380 (negro)	M5x16 Ø11 ISO 7380 Allen screw(black)	2	TORNI-I7380-493
21		Arandela de goma Ø4,5 x Ø11 x2 mm	Ø4,5 x Ø11 x2 mm rubber washer	6	ARAND-EPDM--722
22		Tornillo Allen M6x16 Ø14 ISO 7380 (negro)	M6x16 Ø14 ISO 7380 Allen screw(black)	4	TORNI-I7380-403
23		Tuerca autoblocante M6	M6 lock nut	4	TUZBM6000000024
24		Silentblock M5	M5 silentblock	2	SILENBTM5-046/1
25		Arandela nylon M5x1	M5x1 nylon washer	6	ARNV00000000245
26		Tornillo Allen M5x11 Ø11 ISO 7380 (negro)	M5x11 Ø11 ISO 7380 Allen screw (black)	6	TORNI-AI----520
27		Tornillo Allen M6x20 Ø14 ISO 7380(negro)	M6x20 Ø14 ISO 7380 Allen screw(black)	6	TORNI-I7380-404
28		Tornillo Allen M4x16 Ø7 ISO 7380(negro)	M4x16 Ø7 ISO 7380 Allen screw (black)	3	TORNIAI7380-310
29		Arandela nylon M4	M4 nylon washer	6	ARNV00000000311
30		Tuerca autoblocante M4	M4 Lock nut	3	TUERCAE985-0290
31		Silentblock Ø18 x Ø9 x Ø11 x8 mm	Ø18 x Ø9 x Ø11 x8 mm Silentblock	1	SILENBGONE--064
32		Arandela metálica M6 DIN9021 (negro)	M6 DIN9021 metallic washer (black)	6	ARANDDP9021-037
33		Arandela de goma Ø4,5 x Ø14 x 4mm	Ø4,5 x Ø14 x 4mm Rubber washer	3	ARAND-GD13D5X4-
34		Ribete longitud 230mm, 8mm, espesor 5	Trim lenght 230mm, 8mm, thickness 5	1	PERFIL-PVC-1048
35		Kit adhesivos HUSQVARNA	HUSQVARNA Stickers set	1	10816