

# 2.0 MULTI-ADJUSTABLE VISOR ( FIX )

## M O U N T I N G I N S T R U C T I O N S

REF 20763

UNIVERSAL ( FIXED VERSION )



1 Person

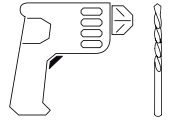

Ø7



15 min



PHILLIPS  
SCREWDRIVER



EASY

ALLEN  
Nº 4



ID	PIEZA/PART	DESCRIPCIÓN	DESCRIPTION	QTY	REF
1		Visera de policarbonato antirayadas	Antiscratch polycarbonate Visor	1	20765H/WM3
2		Plantilla	Template	1	PLANTILLA-VISOR
3		Mecanismo Izquierdo	Left Mechanism	1	See exploding page 2
4		Mecanismo Derecho	Right Mechanism	1	See exploding page 2

# 2.0 MULTI-ADJUSTABLE VISOR ( FIX )

INSTRUCCIONES DE MONTAJE - MOUNTING INSTRUCTIONS - MONTAGEANLEITUNG

1

EXPLOTING

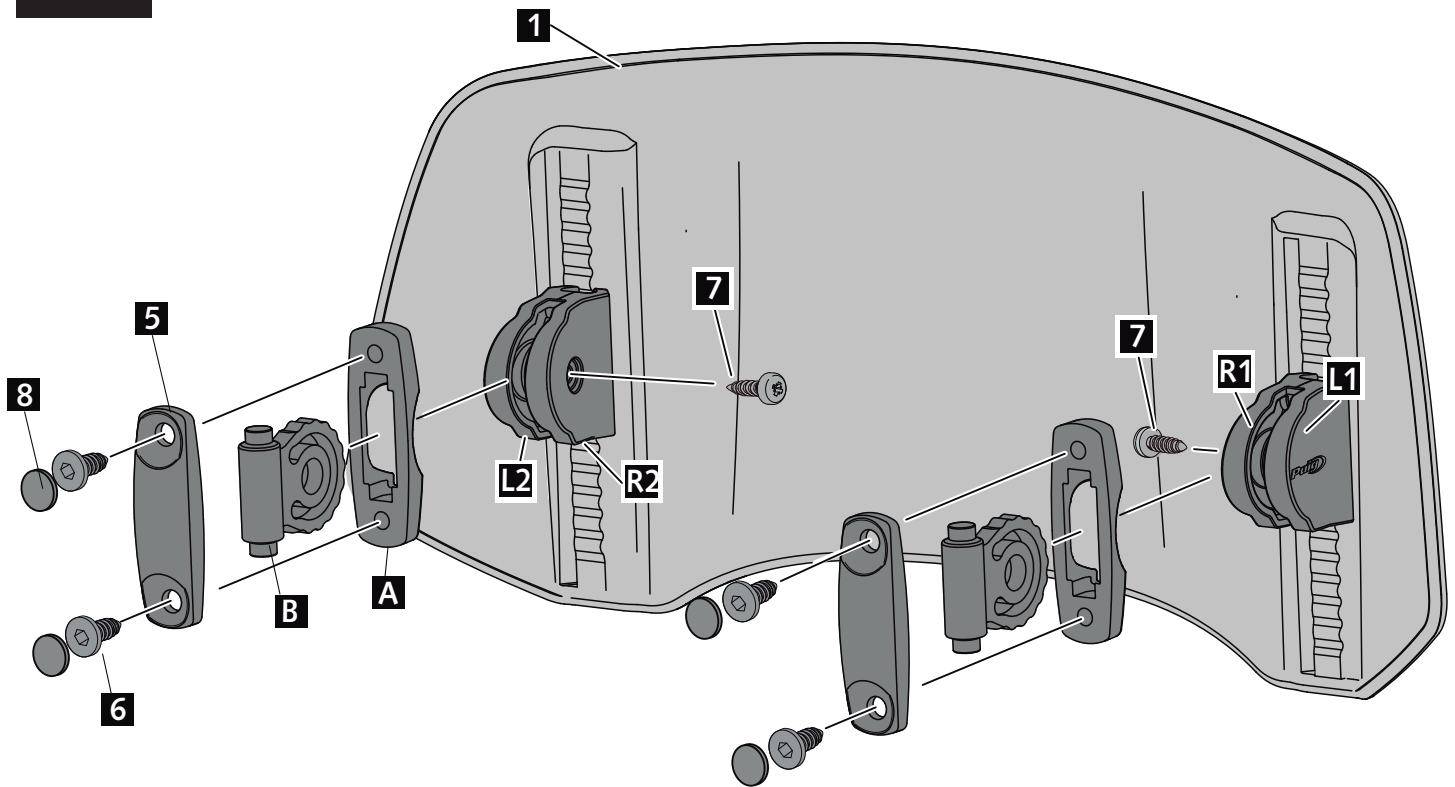

ID	PIEZA/PART	DESCRIPCIÓN	DESCRIPTION	QTY	REF
A		Tapa pieza eje	Axle part cover	2	TAPAEJE-VISOR--
B		Pieza eje	Axle part	2	EJE-FIX-VISOR--
L2		Tapa 2 Logo	Logo cover 2	1	TAPALAT-VISORL2
R2		Tapa 2 Tornillo	Screw cover 2	1	TAPALAT-VISORR2
L1		Tapa 1 Logo	Logo cover 1	1	TAPALAT-VISORL1
R1		Tapa 1 Tornillo	Screw cover 1	1	TAPALAT-VISORR1
5		Tapa cúpula	screen cover	2	TAPAFIX-VISOR--
6		Tornillo allen S.T. 6,3 x14	S.T. 6,3 x14 Allen screw	4	TOZN00M60000258
7		Tornillo Ø3,5x9,5 DIN7981 F	Ø3,5x9.5 DIN7981F screw	2	TORNI-D7981-885
8		Tapón tornillo M6	M6 Screw cap	4	TAPON-----81

## 2.0 MULTI-ADJUSTABLE VISOR ( FIX)

INSTRUCCIONES DE MONTAJE - MOUNTING INSTRUCTIONS - MONTAGEANLEITUNG

2

ASSEMBLY  
MONTAJE

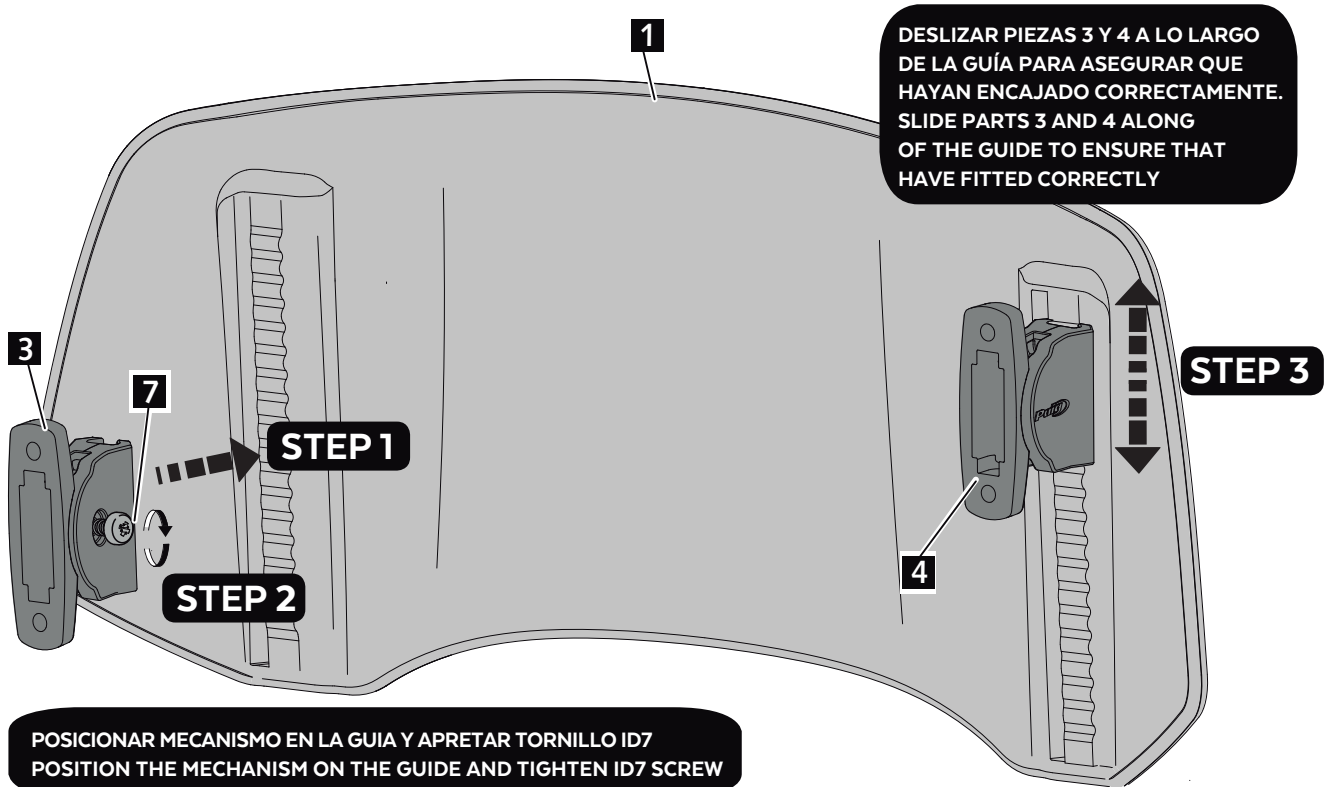

PAR APRIETE TORNILLO ID7 1,4 Nm  
TIGHTENING TORQUE FOR ID7 SCREWS 1,4 Nm

# 2.0 MULTI-ADJUSTABLE VISOR (FIX)

INSTRUCCIONES DE MONTAJE - MOUNTING INSTRUCTIONS - MONTAGEANLEITUNG

**3**

SCREEN TYPE “ ——— ”

ASSEMBLY  
MONTAJE

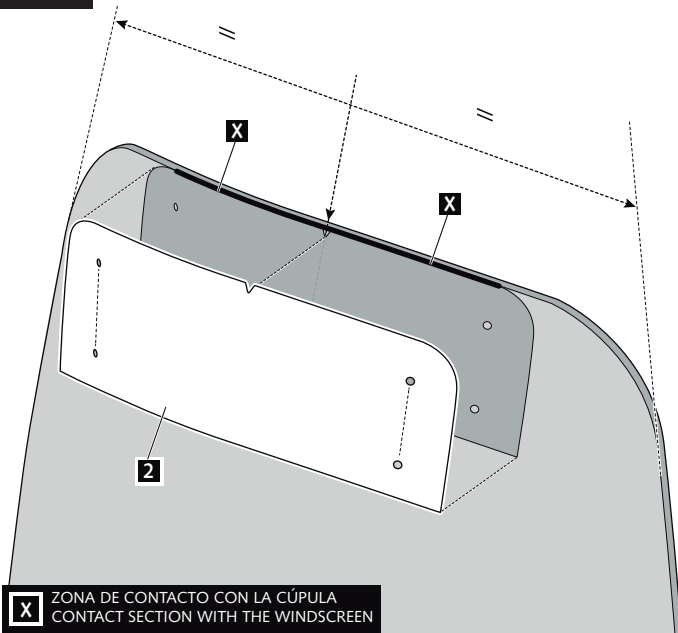

SCREEN TYPE “ ——— ”

**3**

ASSEMBLY  
MONTAJE

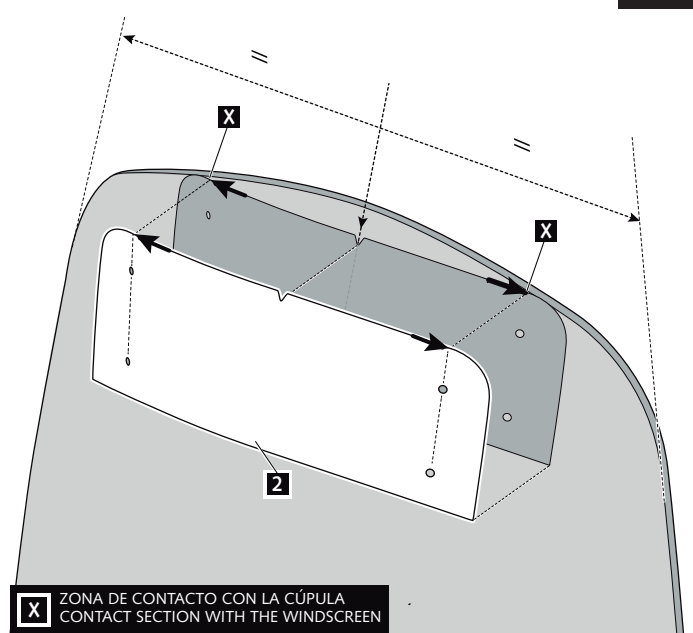

**3**

SCREEN TYPE “ ——— ”

ASSEMBLY  
MONTAJE

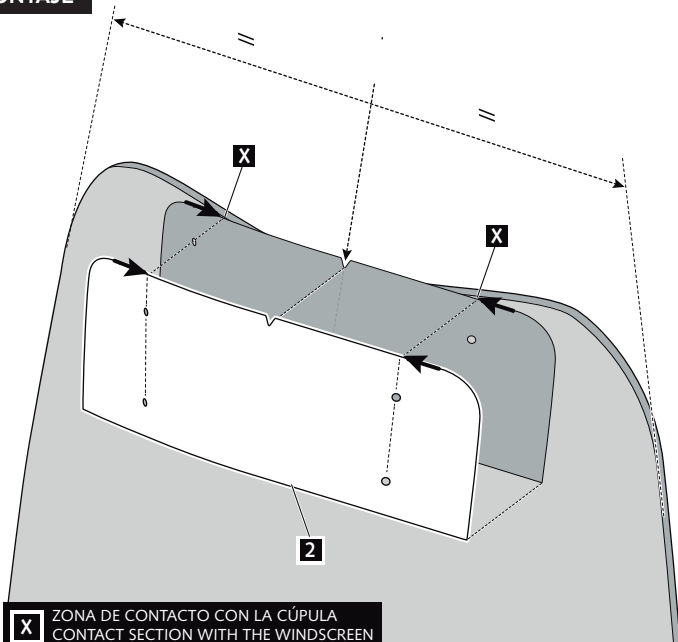

**4**

ASSEMBLY  
MONTAJE

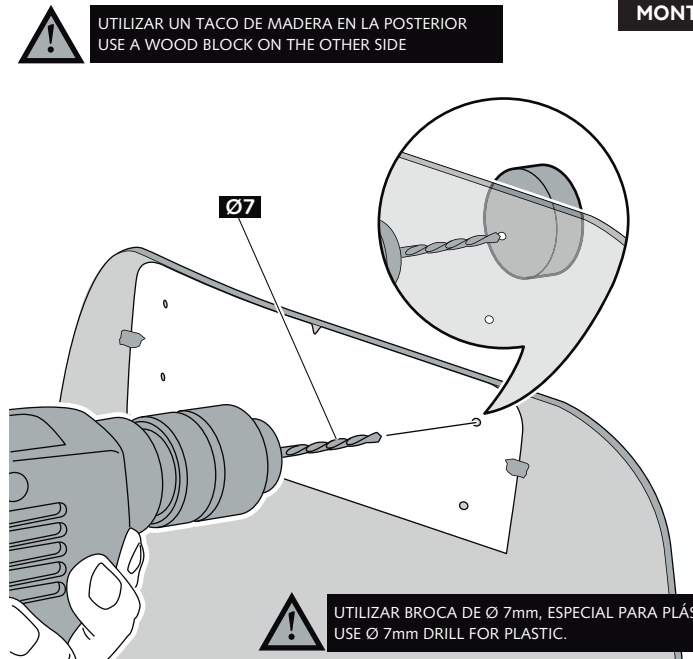

## 2.0 MULTI-ADJUSTABLE VISOR ( FIX)

INSTRUCCIONES DE MONTAJE - MOUNTING INSTRUCTIONS - MONTAGEANLEITUNG

5

ASSEMBLY  
MONTAJE

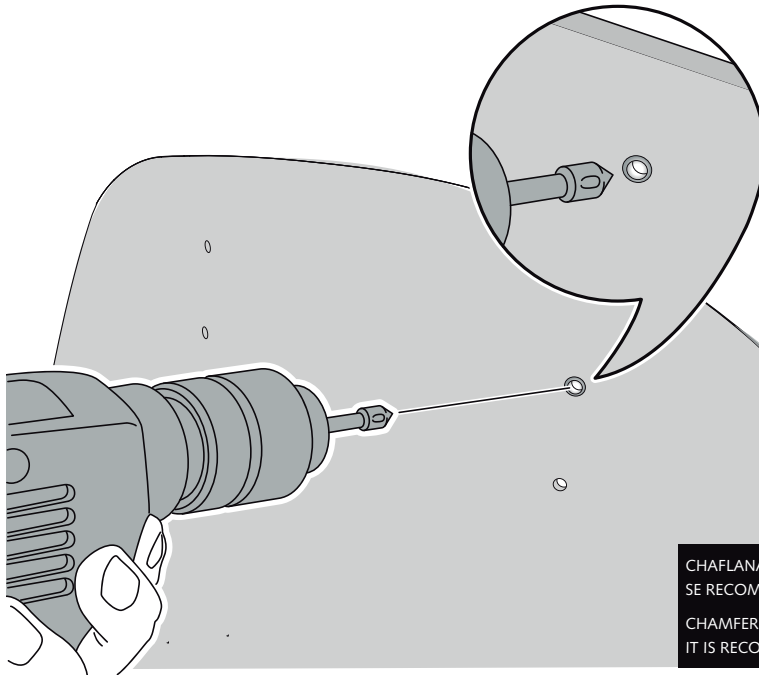

CHAFLANAR LOS 4 AGUJEROS POR AMBOS LADOS.  
SE RECOMIENDA REALIZAR CHAFLAN  $\varnothing 10\text{mm} - \varnothing 20\text{mm}$   
CHAMFER THE FOUR HOLES ON BOTH SIDES.  
IT IS RECOMMENDED TO MAKE CHAMFER  $\varnothing 10\text{mm} - \varnothing 20\text{mm}$

6

ASSEMBLY  
MONTAJE

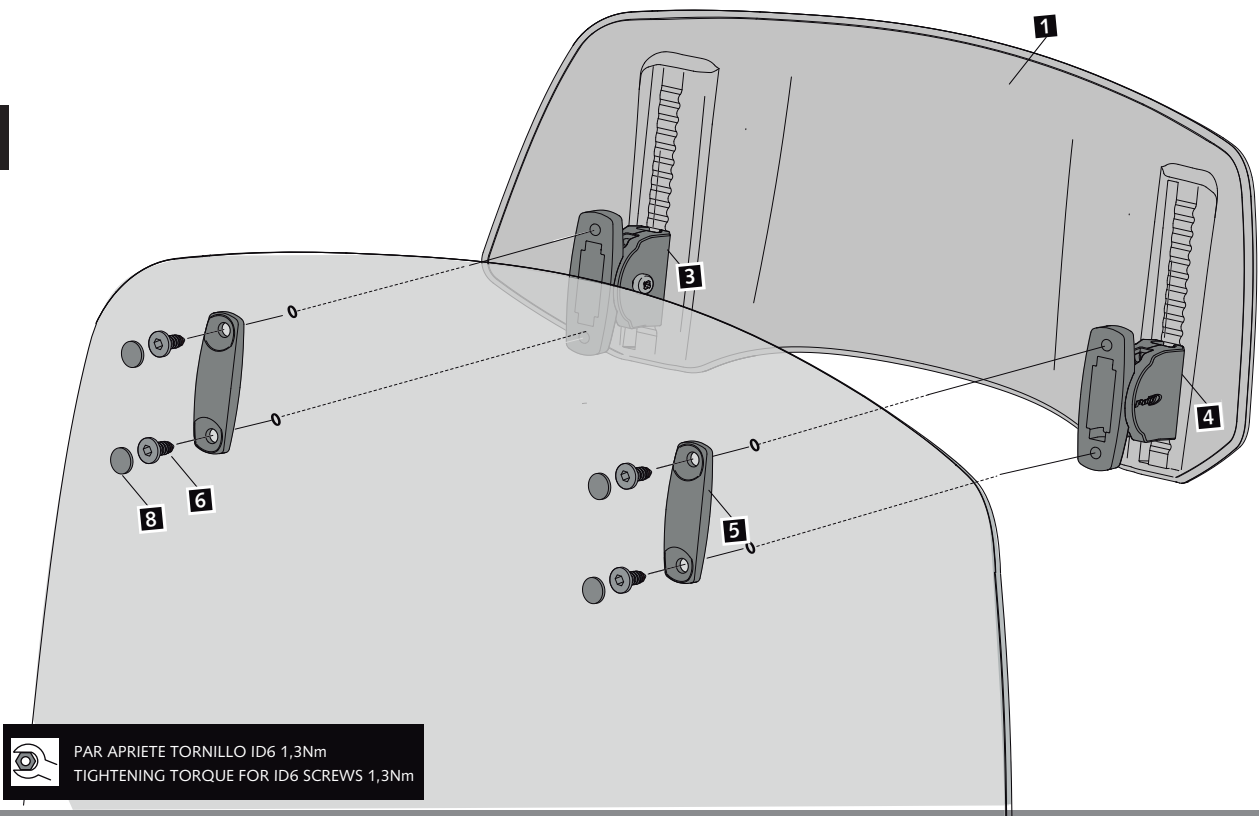

PAR APRIETE TORNILLO ID6 1,3Nm  
TIGHTENING TORQUE FOR ID6 SCREWS 1,3Nm