

SHAD

ENGINEERED FOR RIDING



MORE INFO



NEW TERRA SADDLE BAGS / **TR40**

WWW.SHAD.ES

SRP PRICE LIST

COMPANY

P. 4

P. 26

CASES

TERRA



TOP



SIDE



ACCESSORIES



FITTING KITS



COMFORT SEATS



SPORT



TOURING



SCOOTER



PIN SYSTEM



CAFE RACER



ADVENTURE



ACCESSORIES FOR BAGS



RIDER

SMARTPHONE HOLDERS NEW



RAIN JACKETS



RAIN PANTS



HAND MUFFS



ATV CASES



SHAD LOCKS



FULLY EQUIPPED

P. 126

SPARE PARTS

P. 127

SHAD SUPPORT

P. 127

DISPLAYS

P. 128

ICONS

P. 130

SRP PRICE LIST (VAT INCLUDED)



CATALOGUE LANGUAGES:
Find your translation scanning this QR Code.

Conditions of purchase ⁽¹⁾

Recommendations

- SHAD recommends keeping our suggested public price on e-commerce sites (Suggested Retail Price).
- SHAD recommends checking the current legal regulations for any installation that involves the alteration of any original component of the motorcycle.

sembly indicated by the brand. The end customer is entitled to request the guarantee of his/her product, always provided with the proof of purchase (purchase receipt, invoice or cash receipt).

NOTE: ALL TESTS OF OUR PRODUCTS HAVE BEEN CARRIED OUT WITH THE ORIGINAL (UNMODIFIED) MOTORCYCLES.

Guarantee and claims

All SHAD products are subject to a limited warranty (minimum of 24 months from the date of purchase), modifiable according to the current legislation of each country; according to the proper use and correct as-

The assembly of the SHAD products on in third-party mounting plates and racks, as well as the alteration, MODIFICATION OR ALTERATION of our products or original motorcycle elements will not be covered by the SHAD warranty.

Condiciones de compra ⁽¹⁾

Recomendaciones

- SHAD recomienda mantener en los apartados públicos de cualquier web nuestro precio público sugerido (Suggested Retail Price).
- SHAD recomienda verificar la normativa legal vigente para cualquier instalación que suponga la alteración de cualquier elemento original de la moto.

usen correctamente, de acuerdo con el uso adecuado y el ensamblaje correcto indicado por la marca. El cliente final tiene derecho a solicitar la garantía de su producto, siempre con el comprobante de compra (recibo de compra, factura o recibo de caja).

NOTA: TODAS LAS PRUEBAS DE NUESTROS PRODUCTOS HAN SIDO REALIZADAS CON EL EQUIPAMIENTO DE SERIE EN LAS DIFERENTES MOTOCICLETAS Y MODELOS,

Garantías y reclamaciones

Todos los productos SHAD están sujetos a una garantía limitada (mínima de 24 meses desde la fecha de compra), modificable según la legislación vigente de cada país; siempre y cuando, los productos se

El montaje del producto SHAD en fijaciones y parrillas de terceros, así como la alteración, MODIFICACIÓN O REFORMA de nuestros productos o de elementos originales de la moto suponen la pérdida de la garantía.

Condition d'achat ⁽¹⁾

Recommandations:

- SHAD recommande de conserver notre prix public suggéré (Suggested Retail Price) dans les sections publiques de n'importe quel site Web.
- SHAD recommande de vérifier la législation en vigueur pour toute installation qui implique la modification de tout élément d'origine de la moto.

utilisés correctement, en fonction de l'usage prévu et du montage recommandé par la marque. Le client final est en droit de faire une demande de garantie sur son produit toujours avec la preuve d'achat (facture, reçu ou ticket de caisse).

NOTE : TOUS LES TESTS DE NOS PRODUITS ONT ÉTÉ RÉALISÉS AVEC L'EQUIPEMENT DE SÉRIE SUR LES DIFFÉRENTS MODÈLES DE MOTO.

Garanties et réclamations

Tous les produits SHAD sont soumis à une garantie limitée (minimum de 24 mois à compter de la date d'achat), modifiable selon la législation en vigueur de chaque pays; à condition que les produits soient

Le montage du produit SHAD sur des fixations et platines de tierces, ainsi que la modification, MODIFICATION OU RÉNOVATION de nos produits ou des éléments originaux de la moto entraînent la perte de la garantie.

Condizioni di acquisto ⁽¹⁾

Raccomandazioni

- SHAD consiglia di applicare il listino prezzi al pubblico suggerito (Suggested Retail Price) nelle sezioni pubbliche di qualsiasi sito web.
- SHAD consiglia di verificare la legislazione vigente per l'installazione di prodotti che comporti l'alterazione di qualsiasi elemento originale della motocicletta.

prodotti siano utilizzati correttamente, nel rispetto dell'uso corretto e del corretto assemblaggio indicato dal marchio. Il cliente finale ha facoltà di richiedere la garanzia del proprio prodotto, dietro presentazione di prova di acquisto (scontrino di acquisto, fattura o scontrino).

NOTA: I TEST DEI NOSTRI PRODOTTI SONO STATI EFFETTUATI SULLE DIFFERENTI MOTO E MODELLI CON EQUIPAGGIAMENTO DI SERIE.

Garanzie e reclami

Tutti i prodotti SHAD sono soggetti a una garanzia limitata per eventuali difetti di fabbricazione (minimo 24 mesi dalla data di acquisto), modificabile secondo la legislazione vigente di ogni paese; a condizione che i

L'assemblaggio del prodotto SHAD su kit di fissaggio o piastre di terzi, l'alterazione, la MODIFICA o RIFORMA dei nostri prodotti o di elementi originali della motocicletta, comportano la perdita della garanzia.

Einkaufsbedingungen

Empfehlungen

- SHAD empfiehlt die Beibehaltung unseres empfohlenen Verkaufspreises in den öffentlichen Bereichen jeder Website
- SHAD empfiehlt, die geltende Gesetzgebung für jede Installation zu überprüfen, die die Änderung eines beliebigen Originalelements des Motorrades betrifft.

die Garantie für sein Produkt zu verlangen, immer mit dem Kaufbeleg (Kaufbeleg, Rechnung oder Kassenzettel).

ANMERKUNG: ALLE TESTS UNSERER PRODUKTE WURDEN MIT DER SERIENAUSSTATTUNG DER VERSCHIEDENEN MOTORRÄDER UND MODELLE DURCHFÜHRT.

Garantien und Ansprüche

Alle SHAD-Produkte haben eine 24-monatige beschränkte Garantie, vorausgesetzt, die Produkte werden korrekt verwendet, in Übereinstimmung mit der ordnungsgemäßen Verwendung und der korrekten Montage, die von der Marke angegeben wird. Der Endkunde ist berechtigt,

Die Montage des SHAD-Produktes an Haltern oder Adapterplatten von Drittherstellern, sowie die Veränderung, Modifikation oder Umgestaltung unserer Produkte oder von Original-Elementen des Motorrades führen zum Verlust der Garantie.

Condições de Compra

Recomendações

- A SHAD recomenda manter nas secções públicas de qualquer site o nosso preço de venda ao público sugerido (Suggested Retail Price)
- A SHAD recomenda verificar a legislação vigente para qualquer instalação que suponha a alteração de qualquer elemento original da moto.

a utilização adequada e o encaixe correto indicado pela marca. O cliente final tem direito a solicitar a garantia do seu produto, sempre com o comprovativo de compra (recibo de compra, fatura ou recibo de caixa).

NOTA: TODOS OS TESTES REALIZADOS AOS NOSSOS PRODUTOS FORAM FEITOS COM O EQUIPAMENTO DE SÉRIE NAS DIFERENTES MOTOCICLETAS E MODELOS.

Garantias e reclamações

Todos os produtos SHAD têm uma garantia limitada de 24 meses, sempre que os produtos sejam utilizados corretamente, de acordo com

A montagem do produto SHAD em fixações ou grelhas de terceiros, assim como a alteração, MODIFICAÇÃO OU REFORMA dos nossos produtos ou de elementos originais da moto supõem a perda da garantia.

(1) More info at SHAD B2B
Más información en SHAD B2B
Plus d'informations sur SHAD B2B



(1) Ulteriori informazioni su SHAD B2B

SHAD TERRA

ENGINEERED FOR RIDING



MORE INFO PAG 40

| Terra Top Cases | | Mounting Plate + Screws | Inner bag | Backrest |
|---|-----------|--|-----------|----------|
| TR37  | D0TR37100 | REQUIRED: D1B591PA/D1BTRPA/D1BTRPA2 | X0IB47 | D0RI75 |
| | 335,00 € | 50,11€/105€/96,90€ | 59,00 € | 74,90 € |
| TR48  | D0TR48100 | REQUIRED: D1B591PA/D1BTRPA/D1BTRPA2 | X0IB47 | D0RI75 |
| | 375,90 € | 50,11€/105€/96,90€ | 59,00 € | 74,90 € |

| Terra Side Cases | | Inner bag | Inner Mesh | Lock + Key |
|--|--------------------|-----------|------------|------------|
| TR36R  | D0TR36100R (right) | X0IB47 | INCLUDED | INCLUDED* |
| | 369,90 € | 59,00 € | | |
| TR36L  | D0TR36100L (left) | X0IB47 | X0TR01 | D1TRBOR |
| | 345,00 € | 59,00 € | 10,00 € | 22,98 € |
| TR47R  | D0TR47100R (right) | X0IB47 | INCLUDED | INCLUDED* |
| | 389,00 € | 59,00 € | | |
| TR47L  | D0TR47100L (left) | X0IB47 | X0TR01 | D1TRBOR |
| | 375,00 € | 59,00 € | 10,00 € | 22,98 € |



* 3 cylinders for left, right and top cases + 2 keys

| Terra Saddle Bags | | Description | Measurements | Price |
|--|---------|---------------------------------|-------------------|----------|
| TR40 2u.  | X0TR401 | Adventure Terra Saddle Bags 64l | 49,5x41,8x28,2 cm | 459,00 € |

SHAD TERRA BLACK EDITION ALUMINIUM CASES



MORE INFO PAG 40

| Terra Top Cases | | Mounting Plate + Screws | Inner bag | Backrest |
|--|------------|--|-----------|----------|
| TR37 BLACK EDITION  | D0TR37100B | REQUIRED: D1B591PA/D1BTRPA/D1BTRPA2 | X0IB47 | D0RI75 |
| | 355,00 € | 50,11€/105€/96,90€ | 59,00 € | 74,90 € |
| TR48 BLACK EDITION  | D0TR48100B | REQUIRED: D1B591PA/D1BTRPA/D1BTRPA2 | X0IB47 | D0RI75 |
| | 397,00 € | 50,11€/105€/96,90€ | 59,00 € | 74,90 € |

| Terra Side Cases | | Inner bag | Inner Mesh | Lock + Key |
|---|---------------------|-----------|------------|------------|
| TR36R BLACK EDITION  | D0TR36100RB (right) | X0IB47 | INCLUDED | INCLUDED* |
| | 389,90 € | 59,00 € | | |
| TR36L BLACK EDITION  | D0TR36100LB (left) | X0IB47 | X0TR01 | D1TRBOR |
| | 362,10 € | 59,00 € | 10,00 € | 22,98 € |
| TR47R BLACK EDITION  | D0TR47100RB (right) | X0IB47 | INCLUDED | INCLUDED* |
| | 399,00 € | 59,00 € | | |
| TR47L BLACK EDITION  | D0TR47100LB (left) | X0IB47 | X0TR01 | D1TRBOR |
| | 389,00 € | 59,00 € | 10,00 € | 22,98 € |

* 3 cylinders for left, right and top cases + 2 keys



TOP CASES SRP 2022



| | Top Cases | Packs | Mounting Plate + Screws | Inner bag | Backrest | Brake Light | Upper Rack | Colour Covers |
|----------------------------|---|---|--------------------------|-------------------|---------------------|------------------------------------|-------------------|--------------------------------|
| SH26 | D0B26100 60,90 € | | S INCLUDED | | | D0B29KL ⁽¹⁾ 92,56 € | | |
| SH29 | D0B29100 71,90 € | | S INCLUDED | | D0RI40 26,00 € | D0B29KL ⁽¹⁾ 92,56 € | | D1B29E... 30,70 € / 20,34 € |
| SH33 | D0B33200 84,90 € | | S INCLUDED | | D0RI40 26,00 € | D0B29KL ⁽¹⁾ 92,56 € | | D1B33E8... TBC |
| SH34 | D0B34106 (carbon cover INCLUDED) 89,90 € | | S INCLUDED | | D0RI40 26,00 € | D0B29KL ⁽¹⁾ 92,56 € | | |
| SH37 | D0B37100 109,90 € | | S INCLUDED | | D0RI60 26,00 € | D0B29KL ⁽¹⁾ 92,56 € | | D1B37E... 43,68 € / 27,21 € |
| SH39 | D0B39100 119,90 € | D0B39106 (carbon cover INCLUDED) 129,90 € | M INCLUDED | | D0RI3900 27,90 € | D0B40KL ⁽¹⁾ 105,04 € | | D1B39E... 36,07 € / 24,96 € |
| SH40 | D0B40100 125,40 € | D0B40200 (alu look cover INCLUDED) 150,00 € | M INCLUDED | | D0RI60 26,00 € | D0B40KL ⁽¹⁾ 105,04 € | | D1B40E... 30,95 € / 21,47 € |
| SH40 CARGO | D0B40199 142,00 € | | M INCLUDED | | D0RI60 26,00 € | D0B40KL ⁽¹⁾ 105,04 € | | |
| NEW SH44 | D0B44100 139,00 € | | M INCLUDED | X0IB00 39,90 € | D0RI60 26,00 € | D0B40KL ⁽¹⁾ 105,04 € | | |
| SH45 | D0B45100 145,90 € | | M INCLUDED | X0IB00 39,90 € | D0RI60 26,00 € | D0B40KL ⁽¹⁾ 105,04 € | | D1B45E... 44,72 € |
| SH46 | D0B46200 155,90 € | | M INCLUDED | X0IB00 39,90 € | D0RI50 32,24 € | D0B40KL ⁽¹⁾ 105,04 € | D0PS00 78,41 € | |
| SH47 RED | D0B47206 (carbon cover INCLUDED) 189,90 € | | M INCLUDED | X0IB00 39,90 € | D0RI47 32,90 € | D0B40KL ⁽¹⁾ 105,04 € | | D1B47E... 47,84 € / 29,19 € |
| SH47 WHITE | D0B47106 (carbon cover INCLUDED) 189,90 € | | M INCLUDED | X0IB00 39,90 € | D0RI47 32,90 € | D0B40KL ⁽¹⁾ 105,04 € | | D1B47E... 47,84 € / 29,19 € |
| SH48 DARK GREY | D0B48300 229,00 € | D0B48306R ⁽²⁾ 265,00 € | B INCLUDED A OPTIONAL | X0IB00 39,90 € | D0RI4800 47,90 € | D0B29KL ⁽¹⁾ 92,56 € | D0PS00 78,41 € | D1B48E... 50,96 € |
| SH48 NEW TITANIUM | D0B48400 229,00 € | D0B48406R ⁽²⁾ 265,00 € | B INCLUDED A OPTIONAL | X0IB00 39,90 € | D0RI4800 47,90 € | D0B29KL ⁽¹⁾ 92,56 € | D0PS00 78,41 € | D1B48E... 50,96 € |
| SH50 BACK REST INCLUDED | D0B5000 260,00 € | | B INCLUDED A OPTIONAL | X0IB00 39,90 € | INCLUDED | D0B29KL ⁽¹⁾ 92,56 € | D0PS00 78,41 € | D1B50E... 50,96 € / 36,32 € |
| SH58X CARBON | D0B58206 (carbon cover INCLUDED) 299,90 € | | B INCLUDED A OPTIONAL | X0IB10 47,90 € | D0RI80 75,00 € | D0B29KL ⁽¹⁾ 92,56 € | | D1B58E... 61,15 € |
| SH59X ALUMINIUM | D0B59200 319,90 € | | B INCLUDED A OPTIONAL | X0IB10 47,90 € | D0RI80 75,00 € | D0B29KL ⁽¹⁾ 92,56 € | | |

SIDE CASES

| | Side Cases | Packs | Inner bag | Colour Covers |
|---------------------------|---|--|-------------------|--------------------------------|
| SH23 2 u. | D0B23100 189,90 € | D0B23200W (alu look cover INCLUDED) 219,00 € | | D1B23E... 40,25 € / 17,47 € |
| SH35 ALUMINIUM 2 u. | D0B35200 409,00 € | | X0IB36 30,00 € | |
| SH36 2 u. | D0B36200 (carbon cover INCLUDED) 374,90 € | | X0IB36 30,00 € | D1B36E... 49,92 € |

■ 01 - Blue
 ■ 05 - Silver
 ■ 06 - Carbon
 ■ 08 - White
 ■ 09 - Red
 ■ 15 - New titanium
 ■ 17 - Dark Grey
 ■ 21 - Black
 ER - Non painted cover

⁽¹⁾ These references are not sold separately. On sale in 3 units pack.
⁽²⁾ Buying a minimum number of units

PLATES



S
Small Rack
12,02 €



M
Medium Rack
22,78 €



B
Big Rack
39,38€



A
Aluminium Racks (OPTIONAL)
Aluminium Rack.
Ref. D1BTRPA - 105€
Black Aluminium Rack
Ref. D1BTRPA2 - 96,90€

DISPLAYS



D0EX201

D0EX58

| Display | Ref. | Price |
|---|--------------------------------|----------|
| 3 TOP CASES WALL DISPLAY | D0EX02 | 78,78 € |
| 3 TOP CASES WALL DISPLAY (SH59X/SH58X/SH50/49/48) | D0EX10 | 83,83 € |
| 3 TOP CASES FLOOR STAND | D0EX23 | TBC |
| 9 TOP CASES WALL DISPLAY (SH59X/SH58X/SH50/49/48) | 2 D0EX02 + 1 D0EX10 + 1 D0EX03 | 388,30 € |
| 9 TOP CASES WALL DISPLAY | 3 D0EX02 + 1 D0EX03 | 398,30 € |
| CUBE TOP CASE + 3P SYSTEM | D0EX201 | 420,40 € |
| EXPANDABLE SIGN FOR CUBE (SH59X/SH58X) | D0EX58 | 70,12 € |
| CUBE TERRA TOP + 4P SYSTEM | D0TR201 | 439,42 € |
| TOP CASE WALL DISPLAY | D0EXTRP | 45,81 € |
| TOP CASES SLATWALL DISPLAY | D0EXTRR | 46,58 € |
| 3P SYSTEM WALL DISPLAY | D0EXP1F | 33,63 € |
| 4P SYSTEM WALL DISPLAY | D0EXP4P | 42,19 € |
| PIN SYSTEM FLOOR STAND | D0EXPS01 | 386,02 € |
| PIN SYSTEM TABLE DISPLAY + E04P BAG | D0EXPS031 | 97,77 € |
| SADDLE BAGS DISPLAY | D0EX19SR | 32,82 € |

SPARE PARTS – TOP CASES SRP 2022



SPARE PARTS- CASES

| Top Cases | Mounting Plate | Mounting Plate Screws | Reflector | Locking System | Lock Kit Keys | Lid Stop Strap |
|----------------------|---------------------|-----------------------|---|--|---|-------------------|
| SH26 | D1B29PAR 12,02 € | D1BABOR 6,94 € | D1B261CAR 13,90 € | D1B29MAR 17,06 € | 201722R 8,88 € | D1B1TIR 5,21 € |
| SH29 | D1B29PAR 12,02 € | D1BABOR 6,94 € | D1B291CAR 16,27 | D1B29MAR 17,06 € | 201722R 8,88 € | D1B1TIR 5,21 € |
| SH33 | D1B29PAR 12,02 € | D1BABOR 6,94 € | D1B331CAR 16,44 | D1B341MAR 17,06 € | 201722R 8,88 € | D1B1TIR 5,21 € |
| SH34 | D1B29PAR 12,02 € | D1BABOR 6,94 € | D1B341CAR ⁽¹⁾ D1B342CAR ⁽²⁾ 16,80 € | D1B341MAR 17,06 € | 201722R 8,88 € | D1B1TIR 5,21 € |
| SH37 | D1B37PAR 16,78 € | D1B37BOR 7,22 € | D1B371CAPR 32,59 € | D1B37MAR 17,06 € | 201722R 8,88 € | D1B1TIR 5,21 € |
| SH39 | D1B40PAR 22,78 € | D1B40BOR 9,50 € | D1B39CAR 13,90 € | D1B391MAR 21,17 € | 201722R 8,88 € | D1B1TIR 5,21 € |
| SH40 CARGO | D1B40PAR 22,78 € | D1B40BOR 9,50 € | D1B401CAR D1B403CAR(alu look) 15 € / 16,50€ | D1B45MAR 29,66 € | 201722R 8,88 € | D1B1TIR 5,21 € |
| SH44 | D1B40PAR 22,78 € | D1B40BOR 9,50 € | D1B441CAR TBC | D1B44MAR TBC | 201722R 8,88 € | D1B1TIR 5,21 € |
| SH45 | D1B40PAR 22,78 € | D1B40BOR 9,50 € | D1B451CAR 21,36 € | D1B45MAR 29,66 € | 201722R 8,88 € | D1B1TIR 5,21 € |
| SH46 | D1B40PAR 22,78 € | D1B40BOR 9,50 € | D1B465CAR 34,98 € | D1B46MAR 26,64 € | 201722R 8,88 € | D1B1TIR 5,21 € |
| SH47 | D1B40PAR 22,78 € | D1B40BOR 9,50 € | D1B47CAR (white) D1B471CAR (red) 21,78 € | D1B47MAR 38,72 € | 201722R 8,88 € | D1B1TIR 5,21 € |
| SH48 DARK GREY | D1B59PAR 39,00 € | D1B40BOR 9,50 € | D1B48CAR 21,07 € | D1B481MAR ⁽³⁾ D1B481PMAR ⁽⁴⁾ 45,86€ / 51,25€ | 201896R ⁽³⁾ 203076R ⁽⁴⁾ 16,94€ / 13,31€ | D1B1TIR 5,21 € |
| SH48 NEW TITANIUM | D1B59PAR 39,00 € | D1B40BOR 9,50 € | D1B48CAR 21,07 € | D1B482MAR ⁽³⁾ D1B482PMAR ⁽⁴⁾ 45,86€ / 51,25€ | 201896R ⁽³⁾ 203076R ⁽⁴⁾ 16,94€ / 13,31€ | D1B1TIR 5,21 € |
| SH50 | D1B59PAR 39,00 € | D1B40BOR 9,50 € | D1B50CAR 39,60 € | D1B50MAR 45,20 € | 201896R 16,94 € | D1B1TIR 5,21 € |
| SH58X | D1B59PAR 39,00 € | D1B40BOR 9,50 € | D1B58CAR 33,00 € | D1B59MAR ⁽³⁾ D1B59PMAR ⁽⁴⁾ 46,80€ / 52,19€ | 201896R ⁽³⁾ 203076R ⁽⁴⁾ 16,94€ / 13,31€ | D1B6TIR 6,00 € |
| SH59X | D1B59PAR 39,00 € | D1B40BOR 9,50 € | D1B59CAR 39,60 € | D1B59MAR ⁽³⁾ D1B59PMAR ⁽⁴⁾ 46,80€ / 52,19€ | 201896R ⁽³⁾ 203076R ⁽⁴⁾ 16,94€ / 13,31€ | D1B6TIR 6,00 € |
| TR37 | | | | D1TRTSR(upper part) D1TR37MIR(lower part) 52,27 € / 52,50€ | D1TRB01R 13,31 € | D1B6TIR 6,00 € |
| TR48 | | | | D1TRTSR(upper part) D1TR48MIR(lower part) 52,27 € / 52,50€ | D1TRB01R 13,31 € | D1B6TIR 6,00 € |

| Hinge | Stickers | Box Seal Gasket | Cargo Strap | Side Band | Rubber Stoppers | Others |
|-------------------|---|----------------------|---------------------|----------------------|-------------------|---|
| 201775R 4,60 € | | | | | | |
| 201775R 4,60 € | D1B291ETR 12,10 € | | | | | |
| 201775R 4,60 € | D1B332ETR 10,08 € | | | | | |
| 201775R 4,60 € | 501588R 12,19 € | | | | | D1B34E06 (carbon cover) 34,94 € |
| 201121R 4,55 € | | 400271R 4,82 € | | | | |
| 201121R 4,55 € | D1B39ETR 8,71 € | | | | 202546R 1,51 € | |
| 201121R 4,55 € | D1B401ETR 501910R(alu look) 11,40 € / 11,50 € | 400271R 4,82 € | | | 202546R 1,51 € | D1B40PTR (Upper Rack) 23,04 € |
| 200784R 4,52 € | D1B44ETR TBC | 202467_4R TBC | | | 202546R 1,51 € | |
| 201121R 4,55 € | D1B451ETR 15,89 € | 400271R 4,82 € | D1B45CGR 8,64 € | | 202546R 1,51 € | |
| 201121R 4,55 € | D1B461ETR 23,30 € | 400271R 4,82 € | D1B46CGR 9,94 € | | 202546R 1,51 € | |
| 200784R 4,52 € | D1B47ETR 10,89 € | 202467_3R 9,68 € | | | | D1B47E06 (carbon cover) 47,84 € |
| 200784R 4,52 € | D1B481ETR 23,30 € | 400341_5R 12,29 € | D1B48CGR 9,86 € | D1B481EMR 40,39 € | 200799R 4,46 € | |
| 200784R 4,52 € | D1B482ETR 23,30 € | 400341_5R 12,29 € | D1B48CGR 9,86 € | D1B482EMR 40,39 € | 200799R 4,46 € | |
| 200784R 4,52 € | | 203062R 12,29 € | D1B50CGR 9,86 € | D1B50EMR 47,59 € | 200799R 4,46 € | D0RI70(backrest) 31,20 € |
| 200784R 4,52 € | D1B58ETR 13,20 € | 203062R 12,29 € | D1B59CGR 11,83 € | D1B59EMR 25,20 € | 200799R 4,46 € | D1B59MEALR (Expandable system) 25,80 € |
| 200784R 4,52 € | D1B59ETR 12,00 € | 203062R 12,29 € | D1B59CGR 11,83 € | D1B59EMR 25,20 € | 200799R 4,46 € | D1B59T0R (cover) 125,83 € |
| | | 203507R 12,49 € | | | | X0TR02R (inner mat) 203471R (alu cover) 203471RB(black alu cover) 108,90 € |
| | | 203507R 12,49 € | | | | X0TR02R (inner mat) 203471R (alu cover) 203471RB(black alu cover) 108,90 € |

SPARE PARTS – SIDE CASES

| | | | | | |
|------|--|--|--|--|-------------------|
| SH23 | | D1B23CAR D1B231CAR (alu look) 9,6 € / 11,00 € | D1B23MAR 28,80 € | *200062R 29,71 € | D1B5TIR 4,26 € |
| SH35 | | | D1B362MAR ⁽⁴⁾ 89,00 € | *200062R ⁽³⁾ *203134R ⁽⁴⁾ *203134R1 ⁽⁵⁾ 29,71€/49,61€/18,74€ | D1B5TIR 4,26 € |
| SH36 | | D1B36CAR ⁽³⁾ D1B361CAR ⁽⁴⁾ 16,32 € | D1B362MAR ⁽⁴⁾ 89,00 € | *200062R ⁽³⁾ *203134R ⁽⁴⁾ *203134R1 ⁽⁵⁾ 29,71€/49,61€/18,74€ | D1B5TIR 4,26 € |
| TR36 | | | D1TRTSR (upper part) D1TR36MIR (lower part) 52,27 € / 60,50€ | D1TRBOR 22,98 € | |
| TR47 | | | D1TRTSR (upper part) D1TR47MIR (lower part) 52,27 € / 63,98€ | D1TRBOR 22,98 € | |

| | | | | | | | |
|-------------------|--|----------------------|--------------------|--|---------------------|--|--|
| 201775R 4,60 € | 501720R 501909R (alu look) 10,68 € / 10,75 € | | | | D1B23GOR 12,00 € | D1B23FIR (fitting bracket) 8,40 € | D1B23E25 (cover alu look) 50,00 € |
| 200784R 4,52 € | | 400341_8R 13,78 € | D1B36CGR 7,58 € | | | D1B3613PR (fitting bracket) 20,45 € | D1B35TLR (left side lid) D1B35TRR (right side lid) 88,81 € |
| 200784R 4,52 € | 501424R 10,68 € | 400341_8R 13,78 € | D1B36CGR 7,58 € | | | D1B3613PR (fitting bracket) 20,45 € | D1B36E06 (carbon cover) 49,92 € |
| | | 203507R 12,49 € | | | | D1TR361PR (fitting bracket) 18,49 € | 203163R (alu cover) 203163RB (black alu cover) 96,80 € |
| | | 203507R 12,49 € | | | | D1TR361PR (fitting bracket) 18,49 € | 203163R (alu cover) 203163RB (black alu cover) 96,80 € |

⁽¹⁾ Top cases with colour Cover
⁽²⁾ Top cases without colour Cover

⁽³⁾ Red key
⁽⁴⁾ Black key

⁽⁵⁾ Use 1 key with top + side case, red key

* Includes 3 lock cylinders and keys for top and side cases

FITTING KITS SRP 2022

Top fitting
Top Case



| Make, model and year | Ref. | Plate | Price | Ref. | Price | Ref. | Price | Ref. | Ref. | Price | Ref. | Size | Price |
|--|-------------------------|-------|----------|-------------------------------------|----------------------|---------|---------|----------------------|---------|-------------------------|----------|------|---------|
| AEON | | | | | | | | | | | | | |
| ELITE 125/350i (13-14) | | | | | | | | | | *B0ZN33RN | 77,36 € | | |
| URBAN 125/350i (13-14) | | | | | | | | | | *B0ZN33RN | 77,36 € | | |
| APRILIA | | | | | | | | | | | | | |
| SPORT CITY ONE 125 (09-17) | A0SP19ST | S/B | 61,68 € | | | | | | | | | | |
| SPORT CITY ONE 4T/125 (10-17) | A0SP19ST | S/B | 61,68 € | | | | | | | | | | |
| SR MOTARD 50/125 (11-19) | A0SP19ST | S/B | 61,68 € | | | | | | | | | | |
| SR MAX 125/300 (12-17) | G0NX56ST | S/B | 66,90 € | | | | | | | | | | |
| SR 125/200 GT (21-22) | A0SR12ST | U | | | | | | | | | A0SR12SC | 3 | |
| SHIVER 750 / SHIVER GT 750 (07-09) | | | | | | X0182PS | 26,37 € | | | | | | |
| SHIVER 750 (10-17) | | | | | | X0182PS | 26,37 € | | | | | | |
| SHIVER 900 (19-22) | | | | | | X0182PS | 26,37 € | | | | | | |
| ETV 1000 CAPONORD (01-10) | | | | | | X0182PS | 26,37 € | | | | | | |
| ARIIC | | | | | | | | | | | | | |
| CHINF 318 (21-22) | A0CH31ST | U | 102,20 € | | | | | | | | A0CH31SC | 5 | 27,40 € |
| BAJAJ | | | | | | | | | | | | | |
| PULSAR 150 (14-18) | P0NS24ST | S/B | 127,89 € | P0NS24IF | 174,47 € | | | | | | | | |
| PULSAR 200 NS (14-22) | P0NS24ST | S/B | 127,89 € | P0NS24IF | 174,47 € | | | | | | | | |
| PULSAR AS 150/200 (14-18) | P0NS24ST | S/B | 127,89 € | P0NS24IF | 174,47 € | | | | | | | | |
| BENELLI | | | | | | | | | | | | | |
| BN125 (18-22) | B0BN18ST | S/B | 100,94 € | | | | | | | | | | |
| ZENCERO 125/350 (12-14) | | | | | | | | *B0ZN33RN | 77,36 € | | | | |
| LEONCINO 250 (19-22) | B0LN29ST | S/B | 137,04 € | | | X022PS | 26,37 € | D0SS5SE | | | | | |
| BN 251 (16-22) | B0BN27ST | S/B | 121,75 € | B0BN27IF | 126,71 € | X0182PS | 26,37 € | | | | | | |
| BN 302 (15-22) | B0BN35ST | S/B | 100,98 € | B0BN35IF | 76,07 € | | | | | | | | |
| BN 302S (19-22) | B0BN39ST | S/B | 139,95 € | B0BN39IF | 192,70 € | X022PS | 26,37 € | | | | | | |
| LEONCINO 502i (17-22 / LEONCINO TRAIL (20-22) | B0LN57ST | S/B | 108,74 € | B0LN57IF | 163,01 € | X022PS | 26,37 € | B0LN57SE B0LN57SR | | 93,57 € 141,14 € | | | |
| TRK 125 / 251 (19-22) | B0TR57ST | U | 75,63 € | B0TR29IF | 163,01 € | X022PS | 26,37 € | | | | | | |
| TRK 502 (17-19) | B0TR57ST | U | 75,63 € | B0TR57IF | 163,01 € | | | | | | | | |
| TRK 502 (20-22) | B0TX50ST | U | 62,05 € | B0TR57IF | 163,01 € | | | | | | | | |
| TRK 502 X (18-19) | B0TR57ST | U | 75,63 € | B0TX58IF B0TX524P | 163,01 € TBC | | | | | | | | |
| TRK 502 X (20-22) | B0TX50ST | U | 62,05 € | B0TX58IF B0TX524P | 163,01 € TBC | | | | | | | | |
| BN 600/GT (13-18) | | | | | | X0182PS | 26,37 € | | | | | | |
| TRE 899 K / TRE 1130 K (06-17) | | | | | | X0182PS | 26,37 € | | | | | | |
| BMW | | | | | | | | | | | | | |
| G310 GS (17-22) | W0GG37ST | S/B | 44,15 € | W0G317IF | 175,44 € | X0182PS | 26,37 € | | | | | | |
| G310 R (17-22) | W0G317ST | S/B | 117,40 € | W0G317IF | 175,44 € | X0182PS | 26,37 € | | | | | | |
| C EVOLUTION ELECTRIC (15-21) | W0CV17ST | S/B | 74,01 € | | | | | | | | | | |
| C400 X (18-21) | W0CX49ST | S/B | 95,48 € | | | | | | | | W0CX41SC | 5 | 27,40€ |
| C400GT (19-22) | W0CG49ST | S/B | 120,04 € | | | | | | | W0CG49RV ⁽⁴⁾ | 71,18 € | | |
| C 600 (15-21 / C 600 SPORT (12-15) / C 650 SPORT (12-21) | W0CS62ST | S/B | 70,25 € | | | | | | | W0CS62RV ⁽⁴⁾ | 40,41 € | | |
| C650 GT (12-21) | W0CG62ST ⁽¹⁾ | S/B | 59,06 € | | | | | | | W0CG62RV ⁽⁴⁾ | 37,63 € | | |
| F650 GS / DAKAR (04-07) | W0FG64ST ⁽¹⁾ | | 77,40 € | | | | | | | | | | |
| F650 GS / F 800 GS / F 700 GS (08-18) | W0FG68ST | S/B | 48,09 € | W0FG88IF W0FG884P | 163,01 € 190,50 € | X023PS | 53,70 € | | | | | | |
| G650 GS (10-16) | W0FG64ST ⁽¹⁾ | | 77,40 € | | | | | | | | | | |
| F750GS (18-22) | W0FS88ST | U | 55,74 € | W0FS88IF | 200,67 € | | | | | | | | |
| | W0FG78ST | U | 117,13 € | W0FS884P | 221,76 € | X015PS | 26,37 € | | | | | | |
| F800 S (07-15) | W0FR89ST | S/B | 80,50 € | W0FR89IF ⁽³⁾ | 149,22 € | | | | | | | | |
| F800 R (09-15) | W0FR89ST | S/B | 80,50 € | W0FR89IF ⁽³⁾ | 149,22 € | | | | | | | | |
| F800 R (16-21) | W0GT83ST | S/B | 48,09 € | W0FR88IF ⁽³⁾ | 191,00 € | | | | | | | | |
| F800 GT (13-20) | W0GT83ST | S/B | 48,09 € | | | | | | | | | | |
| F850 GS (18-22) | W0FS88ST | U | 55,74 € | W0FS88IF | 200,67 € | | | | | | | | |
| | W0FG78ST | U | 117,13 € | W0FS884P | 221,76 € | X015PS | 26,37 € | | | | | | |
| F850GS ADVENTURE (19-22) | W0GS19ST | B/A | 52,52 € | W0FS88IF W0FS884P | 200,67 € 221,76 € | X015PS | 26,37 € | | | | | | |
| F900R /XR (20-22) | W0FR90ST | U | 114,83 € | W0FR90IF ⁽³⁾ W0FR914P | 162,37 € 221,32 € | X015PS | 26,37 € | W0FR91SR | | 149,17 € | | | |
| S1000 XR (15-19) | W0SX15ST | B | 39,23 € | W0SX15IF ⁽³⁾ | 118,46 € | X015PS | 26,37 € | | | | | | |
| S1000 XR (20-22) | W0SX10ST | U | 39,11 € | W0SX10IF ⁽³⁾ | 155,07 € | X015PS | 26,37 € | | | | | | |
| S1000R (21-22) | TBC | | | | | | | | | | | | |
| R1100 RT (96-06) | W0R16T | S/B | 43,28 € | | | | | | | | | | |
| R1150 GS (99-05) | | | | | | X015PS | 26,37 € | | | | | | |
| R1150 R (01-06) | | | | | | X015PS | 26,37 € | | | | | | |
| R1150 RS (96) / K 1100 LT / R 1150 RT (96-05) | W0R16T | S/B | 43,28 € | | | | | | | | | | |
| R1150 RT (01-04) | W0R16T | S/B | 43,28 € | | | | | X015PS | | 26,37 € | | | |
| K1200 GT/R/S (05-08) | | | | | | X015PS | 26,37 € | | | | | | |

Bike compatibility



Top fitting
Top Case



| Make, model and year | Ref. | Plate | Price | Ref. | Price | Ref. | Price | Ref. | Ref. | Price | Ref. | Size | Price |
|---|----------------------------------|-------|----------|-------------------------|----------------------|----------------|----------|--|------|-------------------------|---------|------|-------|
| K1200 RS (00-04) | | | | | | | | | | X015PS | 26,37 € | | |
| R1200 GS (03-12) | | | | | | | | | | X015PS | 26,37 € | | |
| R1200 GS ADVENTURE (04-13) | DIRECT ASSEMBLY WITH BOTTOM RACK | | | | | | | | | | | | |
| R1200 GS ADVENTURE (14-18) | NO ASSEMBLY WITH BOTTOM RACK | | | W0GS16IF (13-18) | 195,62 € | X015PS | 26,37 € | | | | | | |
| | W0GS19ST | B/A | 52,52 € | W0GS124P (13-18) | TBC | | | | | | | | |
| R1200 GS / R 1200GS LC (13-19) | W0GS13ST | U | 70,04 € | W0GS16IF W0GS124P | 195,62 € TBC | X015PS | 26,37 € | | | | | | |
| R1200 / R / RS (15-19) (full equip version) | W0RS15ST | S/B | 44,84 € | W0RS15IF ⁽³⁾ | 163,01 € | X015PS | 26,37 € | | | | | | |
| R1200 RT (09-13) / K 1600GT (2013) / K 1200GS (2007) | W0RT19ST | S/B | 64,25 € | | | | | | | | | | |
| R1200 RT (14-18) | W0RT14ST | S/B | 57,19 € | | | | | | | | | | |
| RINET 1200/PURE/SCRAMBLER/URBAN 1200 G-S/RACER 1200 (13-22) | | | | | | X027PS | 25,48 € | W0NT13SR ⁽⁵⁾ | | 84,73 € | | | |
| R1250/RS/R (19-22) | W0RS15ST | S/B | 44,84 € | W0RS15IF ⁽³⁾ | 163,01 € | X015PS | 26,37 € | | | | | | |
| | W0RR15ST | S/B | 89,29 € | | | | | | | | | | |
| R1250RT (19-22) | W0RT14ST | S/B | 57,19 € | | | X015PS | 26,37 € | | | | | | |
| R1250GS/HP (19-22) | W0GS13ST | U | 70,04 € | W0GS16IF W0GS124P | 195,62 € TBC | X015PS | 26,37 € | | | | | | |
| R1250GS ADVENTURE/EXCLUSIVE (19-22) | W0GS19ST | B/A | 52,52 € | W0GS16IF W0GS124P | 195,62 € TBC | X015PS | 26,37 € | | | | | | |
| K1300 GT (08-13) | | | | | | X015PS | 26,37 € | | | | | | |
| K 1300 R/S (09-18) | | | | | | X015PS | 26,37 € | | | | | | |
| CF MOTO | | | | | | | | | | | | | |
| 300 SR (19-22) | | | | | | X028PS | 27,14 € | | | | | | |
| 300/400/650 NK (19-22) | | | | | | X028PS | 27,14 € | | | | | | |
| 400GT/650 GT (19-22) | C0GT49ST | U | 80,99 € | | | X028PS | 27,14 € | | | | | | |
| 650 MT (18-22) | C0MT60ST ⁽⁷⁾ | U | 95,45 € | | | X028PS | 27,14 € | | | | | | |
| DAELIM | | | | | | | | | | | | | |
| ROADWIN 125R/250R (06-12) | D0RD16ST | S/B | 93,04 € | | | | | | | | | | |
| ROADWIN 125FV/250RI (06-14) | D0RD16ST | S/B | 93,04 € | | | | | | | | | | |
| S-2 125 / 250 (06-17) | D0S216ST | S/B | 48,92 € | | | | | | | | | | |
| S3 125i/125 Fi/250i (10-21) | D0S310ST | S/B | 65,18 € | | | | | | | | | | |
| XQ1 125/250 (18-22) | D0XQ18ST | S/B | 84,55 € | | | | | | | D0XQ18RV ⁽⁴⁾ | 40,85 € | | |
| XQ2 300 (21-22) | D0XQ18ST | S/B | 84,55 € | | | | | | | | | | |
| DERBI | | | | | | | | | | | | | |
| BOULEVARD 125/250 2T (10-14) | V0FL15ST | S/B | 91,29 € | | | | | | | | | | |
| VARIANT SPORT 125 4T/ 50 2T (12-14) | A0SP19ST | S/B | 61,07 € | | | | | | | | | | |
| DUCATI | | | | | | | | | | | | | |
| MONSTER 797 (16-21) | | | | | | X011PS | 21,42 € | D0MN17SE | | 101,46 € | | | |
| MONSTER S2R (04-08) | | | | | | X011PS | 21,42 € | | | | | | |
| MONSTER S2R 800 (2008) | | | | | | X011PS | 21,42 € | | | | | | |
| MONSTER 821 (17-21) | | | | | | X011PS | 21,42 € | D0MN87SE (with side handles) D0MN17SE (without handles) | | 103,41 € 101,46 € | | | |
| SCRAMBLER 800 ICON/CLASSIC (15-22) | | | | | | | | D0SC88SR ⁽⁵⁾ | | 78,41 € | | | |
| 848 EVO (11-13) | | | | | | X011PS | 21,42 € | | | | | | |
| SUPERSPORT 937 (16-19) | | | | | | X011PS | 21,42 € | D0MN17SE | | 101,46 € | | | |
| MULTISTRADA 950 (2016) | | | | | | D0ML98IF | 262,99 € | | | | | | |
| | | | | | | D0ML98IF | 262,99 € | | | | | | |
| MULTISTRADA 950/S (17-21) | D0ML17ST | U | 170,93 € | D0ML104P | 261,45 € | X017PS | 26,37 € | | | | | | |
| MONSTER S4R / S4RS 800 (04-08) | | | | | | X011PS | 21,42 € | | | | | | |
| MONSTER 1000 (04-08) | | | | | | X011PS | 21,42 € | | | | | | |
| 1098 / 1198 (07-12) | | | | | | X011PS | 21,42 € | | | | | | |
| SCRAMBLER 1100 (21-22) | TBC | | | | | | | | | | | | |
| MULTISTRADA 1200 / ENDURO (10-15) | | | | | | X017PS | 26,37 € | | | | | | |
| MULTISTRADA 1200/ADV/ENDURO (16-21) | D0ML17ST | U | 170,93 € | D0ML98IF D0ML104P | 262,99 € 261,45 € | X017PS (16-18) | 26,37 € | | | | | | |
| MULTISTRADA V4 S1200 (21-22) | D0MV11ST | U | 40,24 € | D0MV114P | 209,00 € | X017PS | 26,37 € | | | | | | |
| MONSTER 1200 (14-16) | | | | | | X011PS | 21,42 € | | | | | | |
| MONSTER 1200 (16-21) | | | | | | | | | | | | | |

FITTING KITS SRP 2022

Top fitting
Top Case



| Make, model and year | Ref. | Plate | Price | Ref. | Price | Ref. | Price | Ref. | Ref. | Price | Ref. | Size | Price |
|---|-------------------------------|-------|----------|-------------|----------|---------|-------------|-------------|----------|----------|---------|------|-------|
| KSR | | | | | | | | | | | | | |
| WORX 125 (2014) | KØRS11ST | S/B | 80,89 € | | | | | | | | | | |
| CODE 125 (2014) | KØRK11ST | S/B | 83,94 € | | | | | | | | | | |
| GILERA | | | | | | | | | | | | | |
| RUNNER 50/ 125/ 150/ 200 (06-08) | GØRN56ST | S/B | 44,28 € | | | | | | | | | | |
| RUNNER 50SP VX 125/ 150/ 200 (03-18) | GØRN56ST | S/B | 44,28 € | | | | | | | | | | |
| RUNNER 50/125/150/200 BLACK SOUL (11-22) | GØRN56ST | S/B | 44,28 € | | | | | | | | | | |
| NEXUS 125 (07-22) | GØNX56ST | S/B | 66,90 € | | | | | | | | | | |
| NEXUS 250 / 500 (06-14) / NEXUS 300 (13-22) | GØNX56ST | S/B | 66,90 € | | | | | | | | | | |
| FUOCO 500 (07-22) | GØFC58ST | S/B | 50,18 € | | | | | | | | | | |
| GP 800 (08-22) | GØGP88ST | S/B | 105,37 € | | | | | | | | | | |
| HARLEY DAVIDSON | | | | | | | | | | | | | |
| PAN AMERICA 1250 (21-22) | HØPN11ST | U | 163,95 | HØPN114P | 217,80 € | | | | | | | | |
| HONDA | | | | | | | | | | | | | |
| LEAD 100 (03-07) / LEAD 125 (08) | DIRECT ASSEMBLY ON MOTORCYCLE | | | | | | | | | | | | |
| LEAD 110 (08-13) | DIRECT ASSEMBLY ON MOTORCYCLE | | | | | | | | | | | | |
| SH125 (15-16) | | | | | | | | HØSH18SC | 5 | 27,40 € | | | |
| SH125 (17-19) | HØSH2ØST | S/B | 52,39 € | | | | | HØSH18SC | 5 | 27,40 € | | | |
| SH125 (20-22) | HØSH2ØST | S/B | 52,39 € | | | | | HØSH2ØSC | 5 | 27,40 € | | | |
| VISION / NSC50/110/125 (11-16) | HØVS12ST | S | 36,59 € | | | | | | | | | | |
| VISION 110/125 (17-20) | HØVS12ST | S | 36,59 € | | | | | HØVS19SC | 3 | 31,46 € | | | |
| VISION 110/125 (21-22) | HØVS12ST | S | 36,59 € | | | | | HØVS11SC | 3 | 27,40 € | | | |
| DYLAN / SES 125 / 150 (02-08) | HØDL12ST | S/B | 70,04 € | | | | | | | | | | |
| SH MODE 125 (14-17) | HØSM13ST | S/B | 36,59 € | | | | | | | | | | |
| SH MODE 125 (21-22) | HØSM13ST | S/B | 36,59 € | | | | | HØSM11SC | 3 | 27,40 € | | | |
| PCX 125/150 (10-17) | HØPC11ST | U | 34,22 € | | | | HØPC1ØRV(4) | 29,64 € | | | | | |
| PCX 125/150 (18-22) | HØPC11ST | U | 34,22 € | | | | HØPC1ØRV(4) | 29,64 € | HØPC11SC | 5 | 27,40 € | | |
| CBR 125/150/250 (04-10) | HØCB14ST | S/B | 103,06 € | | | DØSS5SE | | 82,14 € | | | | | |
| CBR 125 R (11-17) | HØCR11ST | S/B | 98,26 € | | | | | | | | | | |
| FORZA 125 (15-16) | HØFR15ST | U | 61,68 € | | | | HØFR17RV(4) | 67,95 € | | | | | |
| FORZA 125 (17-20) | HØFR15ST | U | 61,68 € | | | | HØFR17RV(4) | 67,95 € | HØFR3ØSC | 5 | 27,40 € | | |
| FORZA 125/ 350 (21-22) | HØFR11ST | U | 126,00 € | | | | HØFR11RV(4) | 67,95 € | HØFR3ØSC | 5 | 27,40 € | | |
| CBF 125 (08-14) | HØCB19ST | S/B | 88,86 € | | | | | | | | | | |
| CB 125 F / TWISTER (15-20) | HØCF19ST | S/B | 97,44 € | | | | | | | | | | |
| CB 125 F (21-22) | HØCF11ST(11) | S/B | 105,97 € | | | | | | | | | | |
| CB125R/3ØØR NEO SPORTS CAFÉ (18-22) | HØCN18ST | S/B | 113,47 € | | | XØ1ØPS | 21,42 € | | | | | | |
| MSX 125 (17-20) | HØMS17ST | S | 63,34 € | | | | | | | | | | |
| CB19ØR (16-21) | | | | *HØCB16IF | 171,82 € | | | | | | | | |
| CBF 250 (04-08) | HØCB24ST | S/B | 96,70 € | | | | | | | | | | |
| CRF 250 (12-17) | HØCR22ST | S/B | 70,25 € | | | XØ1ØPS | 21,42 € | | | | | | |
| CBR 250 R (11-17) | HØCR11ST | S/B | 98,26 € | | | | | | | | | | |
| FORZA 300 (13-17) | HØFR33ST | S/B | 42,86 € | | | | HØFR33RV(4) | 38,83 € | | | | | |
| FORZA 300 (18-20) | HØFR15ST | U | 61,68 € | | | | HØFR17RV(4) | 67,95 € | HØFR3ØSC | 5 | 27,40 € | | |
| CB300 R/F (11-16) | HØCR11ST | S/B | 98,26 € | | | | | | | | | | |
| SH 30Øi (15-18) | | | | | | | | | HØSH39SC | 5 | 27,40 € | | |
| SH 30Øi (19-20) | HØSH39ST | U | 54,79 € | | | | | | HØSH39SC | 5 | 27,40 € | | |
| SH 35Øi (21-22) | HØSH31ST | U | 69,08 € | | | | | | HØSH31SC | 5 | 27,40 € | | |
| ADV 350 (22) | HØFR15ST | U | 61,68 € | | | | | HØFR17RV(4) | 67,95 € | | | | |
| CB40ØX (16-19) | | | | HØCX59IF(3) | 169,53 € | | | | | | | | |
| | | | | HØCF67IF(3) | 201,05 € | | | | | | | | |
| CBF 500 (04-08) | HØCB64ST | S/B | 90,54 € | | | | | | | | | | |
| CB500F (13-15) / CBR50ØR (14-15) | HØCF54ST | B | 152,29 € | | | | HØCF54SE(5) | 97,60 € | DØSS5SE | 82,14 € | | | |
| CB500F/ CBR50ØR (16-18) | HØCB56ST | B | 146,91 € | HØCB56IF | 194,96 € | XØ1ØPS | 21,42 € | HØCX56SE(5) | 84,48 € | | | | |
| CB500F/ CBR50ØR (19-21) | HØCB59ST | B | 126,11 € | | | XØ1ØPS | 21,42 € | | | | | | |
| CB 500 X (13-15) | HØCX56ST | B | 117,59 € | | | | | HØCF54SE(5) | 97,60 € | | | | |
| CB 500 X (16-18) | HØCX56ST | B | 117,59 € | HØCX59IF(3) | 169,53 € | XØ1ØPS | 21,42 € | HØCX56SE(5) | 84,48 € | | | | |
| | | | | HØICX594P | 208,94 € | | | | | | | | |
| CB 500 X (19-22) | HØCX56ST | B | 117,59 € | HØCX59IF(3) | 169,53 € | | | HØCX56SE(5) | 84,48 € | | | | |
| | | | | HØICX594P | 208,94 € | | | | | | | | |
| REBEL 500 (17-22) | NADTN(1) | S/B | 113,93 € | HØRB57IF | 163,01 € | XØ1ØPS | 21,42 € | | HØRB57SN | 134,86 € | | | |
| | NADTNN(2) | S/B | 78,29 € | | | | | | | | | | |
| CBR 600 F (01-08) | HØCB61ST | S/B | 77,34 € | | | | | | | | | | |
| CBR 600 F (11-13) | | | | | | | | | XØ19PS | 21,42 € | | | |
| CBR 600 RR (05-09) | | | | | | | | | XØ19PS | 21,42 € | | | |
| CBR 600 RR FIREBLADE (2017) | | | | | | | | | XØ19PS | 21,42 € | | | |
| CBR 650 (14-18) | HØCF64ST | B | 96,17 € | HØCF64IF(3) | 159,76 € | | | | XØ1ØPS | 21,42 € | | | |
| HØRNET CB 600 F (07-10) | HØHR67ST | S/B | 118,13 € | | | | | | XØ19PS | 21,42 € | | | |

Bike compatibility



Top fitting
Top Case



| Make, model and year | Ref. | Plate | Price | Ref. | Price | Ref. | Price | Ref. | Ref. | Price | Ref. | Size | Price |
|---|--------------|-------|----------|--------------------|----------|--------|---------|-------------|-------------|-------------|----------|------|---------|
| HØRNET CB 600 F (11-13) | | | | XØ19PS | 21,42 € | | | | | | | | |
| CBF 600 S/N (04 -12) | HØCB64ST | S/B | 90,54 € | HØCF67IF(3) | 201,05 € | XØ19PS | 21,42 € | | | | | | |
| CB 650 (14-17) | | | | XØ1ØPS | 21,42 € | | | | | | | | |
| CB65ØR/CBR65ØR (19-20) | *HØCB69ST | B | 134,32 € | HØCR69IF(3) | 163,00 € | XØ1ØPS | 21,42 € | HØCB69SE | | 81,01 € | | | |
| CB65ØR/CBR65ØR (21) | HØCR61ST | B | 171,29 € | HØCR61IF(3) | 149,99 € | | | HØCR61SE | | 109,14 € | | | |
| CB 650 F / CBR 65ØR (14 -16) | HØCF64ST | B | 96,17 € | HØCF64IF(3) | 159,76 € | | | DØSS5SE | | 82,14 € | | | |
| CB 650 F (16-19) | HØCF64ST | B | 96,17 € | HØCF64IF(3) | 159,76 € | XØ1ØPS | 21,42 € | DØSS5SE | | 82,14 € | | | |
| CTX 700-N (14-18) | HØCT74ST | B | 130,67 € | HØCT74IF(3) | 191,27 € | | | HØCT74RV(4) | | 81,89 € | | | |
| TRANSALP 700 (08-12) | | | | | | XØ19PS | 21,42 € | | | | | | |
| TRANSALP 700 (2013) | | | | | | XØ19PS | 21,42 € | | | | | | |
| FORZA 750 (21-22) | HØFZ71ST | U | 117,20 € | | | | | | | | | | |
| | HØXV71ST(12) | U | 42,11 € | HØXD71IF | 237,91 € | | | | HØXD71RV(4) | 127,66 € | HØFR71SC | 5 | 27,40 € |
| INTEGRA 700 (12-13) / INTEGRA 750 (14-15) | HØNT73ST | B | 103,49 € | HØNT74IF | 177,15 € | | | | | | | | |
| | HØNT74ST(8) | | 99,99 € | | | | | | | | | | |
| INTEGRA 750 (16-21) | HØNG76ST | B | 107,63 € | HØNG77IF | 170,06 € | | | | | | | | |
| NC 700 X/S (12-13) / NC 75ØX/S (14-15) | HØNT73ST | B | 103,49 € | HØNT74IF | 177,15 € | | | | | | | | |
| | HØNT74ST(8) | | 99,99 € | | | | | | | | | | |
| NC 75Ø X/S (16-20) | HØNT75ST | B | 115,09 € | HØNT75IF(3) | 155,41 € | | | | | | | | |
| | | | | HØNC764P | 218,90 € | | | | | | | | |
| NC 75ØX (21) | HØNT75ST | B | 115,09 € | HØNC71IF(3) | 160,30 € | | | | | | | | |
| | | | | HØNC714P | 219,78 € | | | | | | | | |
| X-ADV (17-20) | HØXD77ST(11) | U | 123,51 € | HØXD77IF | 230,12 € | | | | | HØXD77RV(4) | 124,87 € | | |
| | HØXV77ST(12) | | 48,25 € | HØXD774P | 237,89 € | | | | | | | | |
| | | | | HØXD71IF | 237,91 € | | | | | | | | |
| X-ADV (21-22) | HØFZ71ST | U | 117,20 € | | | | | | | HØXD71RV(4) | 127,66 € | | |
| | HØXV71ST(12) | | 42,11 € | HØXD714P | 254,10 € | | | | | | | | |
| CROSSRUNNER VFR 800 X (15 -21) | HØCR85ST | B | 117,22 € | HØCR85IF(3) | 157,58 € | | | | | DØSS5SE | 82,14 € | | |
| VFR 800 VTEC (02-11) | HØVF82ST | B | 123,35 € | HØVF82IF(3) | 163,01 € | XØ19PS | 21,42 € | | | | | | |
| VFR 800 (12-13) | HØVF82ST | B | 123,35 € | HØVF82IF(3) | 163,01 € | | | | | | | | |
| VFR 800 F (14-17) | | | | | | XØ1ØPS | 21,42 € | | | | | | |
| AFRICA TWIN CRF10ØØL (16-19) | HØCR12ST | U | 49,14 € | HØFR16IF(16-17)(3) | 221,70 € | | | | | | | | |
| | | | | HØFR18IF(18-19)(3) | 185,92 € | XØ1ØPS | 21,42 € | | | | | | |
| | HØCR18ST(10) | U | 144,97 € | HØFR194P(18-19) | 250,32 € | | | | | | | | |
| AFRICA TWIN CRF11ØØL (20-21) | HØCR1ØST | B/A | 130,18 € | H | | | | | | | | | |

FITTING KITS SRP 2022

Top fitting

Top Case



Side fitting



Tank bag



Saddle bag holder



Backrest Sissybars



Shad locks

| Make, model and year | Ref. | Plate | Price | Ref. | Price | Ref. | Price | Ref. | Ref. | Price | Ref. | Size | Price |
|---------------------------------------|---|------------|---------------------|---------------------------------|----------|-------------------------|---------|----------------------|-------------------------|---------------------|------|------|-------|
| HYOSUNG | | | | | | | | | | | | | |
| GV 125 AQUILA (18-22) | NADTN ⁽¹⁾ NADTNN ⁽²⁾ | S/B S/B | 113,93 € 78,29 € | H0GV18IF ⁽³⁾ | 163,00 € | | | | H0GV18SN | 147,55 € | | | |
| KAWASAKI | | | | | | | | | | | | | |
| J125 (16-17) / J300 (13-22) | K0J334ST | S/B | 37,63 € | | | | | | K0J334RV ⁽⁴⁾ | 31,36 € | | | |
| Z125 (19-22) | K0Z119ST | S/B | 154,69 € | | | | | | | | | | |
| Z300 (14-17) | | | | | | X025PS | 31,75 € | | | | | | |
| VERSYS-X 300 (17-22) | K0VR37ST | U | 46,19 € | K0VR37IF | 163,01 € | X025PS | 31,75 € | | | | | | |
| NINJA 400 (18-22) | | | | | | X025PS | 31,75 € | | | | | | |
| Z400 (19-22) | K0Z449ST | S/B | 175,01 € | | | X025PS | 31,75 € | | | | | | |
| ER5 500 (02-07) | K0ER57ST | S/B | 114,99 € | | | D0SS5SE | | | | 82,14 € | | | |
| ZX-6R (09-12) | | | | | | X014PS | 21,42 € | | | | | | |
| ER6 N-F 650 (05-08) | K0ER65ST | S/B | 82,59 € | | | X014PS | 21,42 € | | | | | | |
| ER6 N-F 650 (09-11) | K0ER69ST | B | 133,85 € | | | X014PS | 21,42 € | | | | | | |
| ER6 N/6F (12-17) | K0ER62ST | B | 121,26 € | K0ER62IF ⁽³⁾ | 166,28 € | X014PS | 21,42 € | D0SS5SE | | 82,14 € | | | |
| NINJA 650 (17-22) | K0Z667ST | B | 116,71 € | K0Z667IF | 185,78 € | X025PS | 31,75 € | K0Z667SE | | 92,25 € | | | |
| VERSYS 650 (07-09) | K0VR67ST | S/B | 99,10 € | | | | | | | | | | |
| VERSYS 650 (10-14) | K0VR60ST | B | 107,68 € | K0VR60IF ⁽³⁾ | 197,79 € | X014PS | 21,42 € | D0SS5SE | | 82,14 € | | | |
| VERSYS 650 (15-22) | K0VR65ST | B/A | 44,96 € | K0VR65IF ⁽⁶⁾ | 163,01 € | X014PS | 21,42 € | | | | | | |
| VULCAN S 650 (15-22) | NADTN ⁽¹⁾ NADTNN ⁽²⁾ | S/B S/B | 113,93 € 78,29 € | K0VL65IF | 163,01 € | X014PS | 21,42 € | | K0VL65SN | 155,76 € | | | |
| Z650 (16-22) | K0Z667ST | B | 116,71 € | K0Z667IF | 185,78 € | X025PS | 31,75 € | K0Z667SE K0Z667SR | | 92,25 € 140,36 € | | | |
| Z750/R (07-12) | K0Z778ST | B | 130,67 € | | | X014PS | 21,42 € | | | | | | |
| K0Z778CL SR | | S/B | 100,35 € | | | | | | | | | | |
| ZR-7/S (01-05) | K0ZR71ST | S/B | 75,01 € | | | | | | | | | | |
| Z900 (17-22) | K0Z997ST | B/A | 158,34 € | K0Z997IF | 163,01 € | X025PS | 31,75 € | K0Z997SE K0Z997SR | | 104,20 € | | | |
| Z900RS (18-22) / Z900RS CAFÉ (20-22) | K0ZR98ST | B | 159,39 € | K0ZR98IF | 166,12 € | X014PS | 21,42 € | | | | | | |
| H2-SX (15-22) | | | | | | X014PS | 21,42 € | | | | | | |
| KLV 1000 (05-07) | S0VS12ST | S/B | 39,72 € | | | | | | | | | | |
| Z 1000 (07-09) | K0Z778ST | B | 130,67 € | | | | | | | | | | |
| K0Z778CL SR | | S/B | 100,35 € | | | | | | | | | | |
| Z 1000 (10-13) | | | | | | X014PS | 21,42 € | | | | | | |
| Z 1000 SX (11-17) | K0ZS11ST | B | 129,84 € | K0ZS16IF (15-16) | 163,01 € | X014PS | 21,42 € | | | | | | |
| Z 1000 SX (16) (18-20) | K0ZS18ST | B | 164,76 € | | | X014PS | 21,42 € | | | | | | |
| NINJA 1000 SX (21-22) | K0ZS18ST | B | 164,76 € | | | X025PS | 31,75 € | | | | | | |
| ZX-10R (10-12) | | | | | | X014PS | 21,42 € | | | | | | |
| ZX-10R (2018) | | | | | | X014PS | 21,42 € | | | | | | |
| VERSYS 1000 (12-18) | K0GT18ST | S/B | 44,41 € | K0VR16IF ⁽³⁾ (15-18) | 161,71 € | X014PS | 21,42 € | | | | | | |
| VERSYS 1000/S/SE (19-22) | K0GT18ST | S/B | 44,41 € | K0VR19IF ⁽³⁾ | 163,00 € | X025PS | 31,75 € | | | | | | |
| GTR 1400 / CONCOURS 1400 (07-17) | K0GT18ST | S/B | 44,41 € | | | X014PS | 21,42 € | | | | | | |
| ZZR 1400 (02-17) | | | | | | X014PS | 21,42 € | | | | | | |
| ZX-14R (2018) | | | | | | X014PS | 21,42 € | | | | | | |
| KEEWAY | | | | | | | | | | | | | |
| CITY BLADE 125 (15-17) | K0CT15ST | S/B | 42,48 € | | | | | | | | | | |
| K-LIGHT 125 (18-21) | NADTN ⁽¹⁾ NADTNN ⁽²⁾ | S/B S/B | 113,93 € 78,29 € | | | | | | K0KL18SN | 129,52 € | | | |
| SUPERLIGHT 125 (11-21) | NADTN ⁽¹⁾ NADTNN ⁽²⁾ | S/B S/B | 113,93 € 78,29 € | | | | | | K0SP12SN | 144,55 € | | | |
| RKS 125/150/200/200S (11-21) | K0RS11ST | S/B | 80,89 € | | | X022PS | 26,37 € | | | | | | |
| RKV 125/150/200S/200S FACTORY (11-21) | K0RK11ST | S/B | 83,94 € | | | X022PS | 26,37 € | | | | | | |
| RKR 125 (17-21) | | | | | | X022PS | 26,37 € | | | | | | |
| RKF 125 (17-21) | K0RK18ST | B/A | 151,45 € | | | X022PS (only E10P/E16P) | 26,37 € | | | | | | |
| SILVER BLADE 125 (12-17) | K0SL12ST | S/B | 46,00 € | | | | | | | | | | |
| ZAHARA 125 (21-22) | K0ZH11ST ⁽⁷⁾ | B | 47,72 € | | | | | | | | | | |
| VIESTE 125/300 (20-22) | K0VS10ST | S/B | 96,91 € | | | | | | | | | | |
| BLACKSTER 250 (15-22) | NADTN ⁽¹⁾ NADTNN ⁽²⁾ | S/B S/B | 113,93 € 78,29 € | | | | | | K0SP12SN | 144,55 € | | | |
| KTM | | | | | | | | | | | | | |
| DUKE 125 (11-16) / 200 (11-21) | K0DK34ST | S/B | 93,81 € | | | X016PS | 26,37 € | K0DK34SE | | 88,81 € | | | |
| DUKE 125 (17-21) | K0DK17ST | S/B | 78,11 € | | | X021PS (only E10P/E16P) | 26,37 € | K0DK17SE | | 84,04 € | | | |
| DUKE 390 (11-16) | K0DK34ST | S/B | 93,81 € | | | X016PS | 26,37 € | | | | | | |

Bike compatibility



Top fitting

Top Case



Side fitting



Tank bag



Saddle bag holder



Backrest Sissybars



Shad locks

| Make, model and year | Ref. | Plate | Price | Ref. | Price | Ref. | Price | Ref. | Ref. | Price | Ref. | Size | Price |
|---|-------------------------|-------|---------|------------------|----------|----------------|---------|--------|---------|----------|------|-------------------------|-----------|
| DUKE 250/390 (17-21) | K0DK17ST | S/B | 78,11 € | | | | | X021PS | 26,37 € | K0DK17SE | | 84,04 € | |
| DUKE 390 ADVENTURE (21-22) | K0DK30ST | U | 83,38 € | | | | | | | K0DK30SE | | 96,34 € | |
| RC 390 (14-16) | | | | | | | | X016PS | 26,37 € | | | | |
| RC 390 (17-19) | | | | | | | | X016PS | 26,37 € | | | | |
| 790 ADVENTURE / 790 R (19-20) | K0DV17ST | U | 50,81 € | K0DV79IF | 191,35 € | | | | | | | | |
| | | | | K0DV794P | 227,14 € | | | | | | | | |
| 890 ADVENTURE L/R/RALLY (21-22) | K0DV17ST | U | 50,81 € | K0DV79IF | 191,35 € | | | | | | | | |
| | | | | K0DV794P | 227,14 € | | | | | | | | |
| ADVENTURE 1050 (14-16) | K0DV17ST | U | 50,81 € | K0DV17IF | 163,01 € | | | | | | | | |
| | | | | K0SP194P | 184,10 € | | | | | | | | |
| ADVENTURE 1090 R/CLASSIC (14-19) | K0DV17ST | U | 50,81 € | K0DV17IF (17-19) | 163,01 € | X017PS (17-19) | 26,37 € | | | | | | |
| | | | | K0SP194P | 184,10 € | | | | | | | | |
| ADVENTURE 1190 / R (14-16) | K0DV17ST | U | 50,81 € | K0DV17IF | 163,01 € | X017PS | 26,37 € | | | | | | |
| | | | | K0SP194P | 184,10 € | | | | | | | | |
| SUPER ADVENTURE 1290 R/S/T (14-20) | K0DV17ST | U | 50,81 € | K0DV17IF | 163,01 € | X017PS (17-19) | 26,37 € | | | | | | |
| | | | | K0SP194P | 184,10 € | | | | | | | | |
| SUPER ADVENTURE 1290 R/S/T (21-22) | K0DV11ST | U | 46,70 € | K0DV114P | 228,43 € | X0172PS | 40,85 € | | | | | | |
| 1290 SUPERDUKE R (13-20) | | | | | | X017PS | 26,37 € | | | | | | |
| KYMCO | | | | | | | | | | | | | |
| AGILITY 50/125 RS (10-22) | K0GL51ST | S/B | 63,72 € | | | | | | | | | | |
| VITALITY 2T 50 (09-14) | K0VT53ST | S/B | 56,45 € | | | | | | | | | | |
| PEOPLE 125 S (18-22) | K0PP18ST | S/B | 41,95 € | | | | | | | | | K0PP18SC | 5 34,36 € |
| AGILITY CITY/AGILITY 16 + 50 /125i/ 200i 2T/4Ti (14-22) | K0GL14ST | S/B | 44,96 € | | | | | | | | | | |
| AGILITY CITY 125 (16-22) | | | | | | | | | | | | K0GL10SC | 5 27,40 € |
| G - DINK 125i / 150i / 300 (12-16) | K0GD12ST | S/B | 86,56 € | | | | | | | | | | |
| FILLY 125 ABS (18-22) | K0FL18ST | S/B | 63,44 € | | | | | | | | | | |
| LIKE 125 (15-16) | K0LK15ST | S/B | 70,21 € | | | | | | | | | | |
| LIKE 125 (17-20) | K0LK17ST | S/B | 59,35 € | | | | | | | | | | |
| MILLER 125 (21-22) | | | | | | | | | | | | K0ML11SC | 5 27,40€ |
| SUPER DINK/DOWNTOWN/DINK STREET 125-300 (09-15) | K0SP19ST | S/B | 83,67 € | | | | | | | | | | |
| | K0SP19KT ⁽⁵⁾ | S/B | 66,90 € | | | | | | | | | K0SP19RV ⁽⁴⁾ | 36,61 € |
| SUPER DINK/DOWNTOWN 125-350 (16-22) | K0DW15ST | S/B | 70,04 € | | | | | | | | | K0DW15RV ⁽⁴⁾ | 30,44 € |
| | | | | | | | | | | | | K0SP39SC | 7 34,36 € |
| SUPER 8 50/125/150 (21-22) | K0SP51ST ⁽⁷⁾ | | | | | | | | | | | | |
| PULSAR 125 (11-15) | | | | | | | | | | | | | |
| X-TOWN (16-21) / GRAND DINK 125/300 (16-21) | K0GD16ST | S/B | 55,20 € | | | | | | | | | K0GD16RV ⁽⁴⁾ | 34,50 € |
| X-TOWN CITY 125/300 / X-TOWN 125/300 / X-TOWN CT 125/300 (22) | K0XT11ST | U | 55,90 € | | | | | | | | | K0XT11SC | 5 27,40€ |
| XCITING 250/500 (05-11) | K0XC55ST | S/B | 55,34 € | | | | | | | | | | |
| K-XCT 125/ 300i (13-17) | K0XC32ST | S/B | 95,96 € | | | | | | | | | | |
| AGILITY 300 R16 (19-21) | K0GL39ST | | | | | | | | | | | | |

FITTING KITS SRP 2022







| Make, model and year | Ref. | Plate | Price | Ref. | Price | Ref. | Price | Ref. | Ref. | Price | Ref. | Size | Price |
|---|----------------------------------|-------|----------|----------|----------|-----------------|---------|----------|-------------|----------|----------|------|---------|
| TIGER 900/GT/RALLY/PRO (20-22) | T0TG90ST | U | 41,86 € | T0TG904P | 231,83 € | X0182PS | 26,37 € | | | | | | |
| BONNEVILLE T100 900 (18-22) | | | | | | | | T0BN97SR | | 141,11 € | | | |
| STREET SCRAMBLER 900 (18-22) | | | | | | | | T0ST98SR | | 78,41 € | | | |
| SPEED TRIPLE 1050 (08-17) | | | | | | X0182PS | 26,37 € | | | | | | |
| SPRING GT 1050 (10) | | | | | | X0182PS | 26,37 € | | | | | | |
| SPRINT GT 1050 (11-13) | | | | | | X0182PS | 26,37 € | | | | | | |
| SPRINT GT 1050 (14-16) | | | | | | X0182PS | 26,37 € | | | | | | |
| SPRING ST 1050 (05-11) | | | | | | X0182PS | 26,37 € | | | | | | |
| TIGER 1050 (07-12) | | | | | | X0182PS | 26,37 € | | | | | | |
| TIGER SPORT 1050 (15-21) | T0TG16ST | S/B | 93,47 € | T0TG16IF | 163,01 € | X0182PS (13-19) | 26,37 € | | | | | | |
| TIGER EXPLORER 1200 (12-15) | DIRECT ASSEMBLY WITH BOTTOM RACK | | | | | X0182PS | 26,37 € | | | | | | |
| TIGER EXPLORER 1200 (2016) | | | | | | X0182PS | 26,37 € | | | | | | |
| TIGER EXPLORER 1200 (17-21) | T0XP16ST | S/B | 42,41 € | T0XP16IF | 163,01 € | X0182PS | 26,37 € | | | | | | |
| UM | | | | | | | | | | | | | |
| CHILL 125 (19-22) | U0CH59ST | | 66,36 € | | | | | | | | | | |
| RENEGADE SCRAMBLER 125 (18-22) | | | | | | X0182PS | 26,37 € | | | | | | |
| RENEGADE COMANDO/SPORTS S/VEGAS (19-22) | U0RN19ST | | 56,22 € | U0RN19IF | 157,49 € | | | | | | | | |
| SCRAMBLER (17-22) | U0DV18ST | | 85,45 € | U0DV18IF | 179,07 € | | | | | | | | |
| SCRAMBLER CLASSIC/SPORT (17-22) | U0SC18ST | | 74,84 € | | | | | | | | | | |
| DSR ADVENTURE 125 E/VT (18-22) | U0DV18ST | | 85,45 € | U0DV18IF | 179,07 € | X0182PS | 26,37 € | | | | | | |
| VOGE | | | | | | | | | | | | | |
| AC300 (20-22) | V0AC30ST | S | 132,69 € | V0AC30IF | 157,49 € | | | D0SS5SE | | 82,14 € | | | |
| 300R(20-22) | V0VR30ST | U | 143,84 € | V0VR30IF | 157,49 € | | | D0SS5SE | | 82,14 € | | | |
| 500DS (20-22) /500DSX (21-22) | V0DS50ST | U | 44,82 € | V0DS50IF | 157,49 € | | | | | | | | |
| | | | | V0DS504P | 193,60 € | | | | | | | | |
| 500R(20-22) | V0VR50ST(5) | S/B | 134,48 € | | | | | D0SS5SE | | 82,14 € | | | |
| 650DS(21-22) | V0DS61ST | B | 32,43 € | V0DS61IF | 182,64 € | | | | | | | | |
| | | | | V0DS614P | 210,69 € | | | | | | | | |
| 650DSX (21-22) | V0DX61ST | B | 30,66 € | V0DS61IF | 182,64 € | | | | | | | | |
| | V0DS61ST | B | 32,43 € | V0DS614P | 210,69 € | | | | | | | | |
| YAMAHA | | | | | | | | | | | | | |
| NEO'S 50 / 100 (97-07) | Y0N10T | S | 61,68 € | | | | | | | | | | |
| NEO'S 50/ 125 / 4 TEMPI (08-22) | Y0NS58ST | S/B | 86,82 € | | | | | | | | | | |
| AEROX 50/100 (97-08) | Y0A57T | S | 52,68 € | | | | | | | | | | |
| AEROX 50 (13-20) / AEROX 4 (21-22) | Y0RX53ST | S | 74,22 € | | | | | | | | | | |
| WHY 50 (08-13) | DIRECT ASSEMBLY ON MOTORCYCLE | | | | | | | | | | | | |
| JOG II 50 (02-19) | Y0JG52ST | S/B | 73,51 € | | | | | | | | | | |
| CYGNUS X 125 (04-06) | Y0CY14ST | S/B | 51,23 € | | | | | | | | | | |
| CYGNUS X 125 (07-16) | Y0CY17ST | S/B | 60,63 € | | | | | | | | | | |
| DELIGHT 115 (13-18) | Y0DL53ST | S/B | 85,55 € | | | | | | | | | | |
| DELIGHT 125 (17-22) | Y0DL17ST | S/B | 74,17 € | | | | | | | | | | |
| TRICITY 125 (14-22) | Y0TR14ST | S/B | 36,48 € | | | | | | | | | | |
| YBR 125 i / CLASSIC SP (10-22) | DIRECT ASSEMBLY ON MOTORCYCLE | | | | | | | | | | | | |
| MAJESTY S 125 (14-17) | Y0MJ15ST | S/B | 99,31 € | | | | | | | | | | |
| YS 125 (17-21) | Y0YS17ST | S/B | 96,67 € | | | | | | | | | | |
| X-MAX 125-250 (05-09) | Y0XM25ST | S/B | 75,27 € | | | | | | | | | | |
| X-MAX 125-250 (10-13) | Y0XM20ST | S/B | 63,97 € | | | | | | | | | | |
| X-MAX 125 (17-20) | Y0XM37ST | U | 129,79 € | | | | | | Y0XM37RV(1) | 61,68 € | Y0XM11SC | 7 | 27,40 € |
| X-MAX 125 (21) | Y0XM11ST | U | 107,40 € | | | | | | Y0XM37RV(1) | 61,68 € | Y0XM11SC | 7 | 27,40 € |
| X-MAX 125i (14-16) /250(14-17) | Y0XM43ST | S/B | 100,66 € | | | | | | | | | | |
| N MAX 125i (15-20) | Y0NM15ST | S/B | 93,04 € | | | | | | | | | | |
| N MAX 125i (21) | Y0NM11ST(5) | S/B | 98,81 € | | | | | | | | Y0NM11SC | 3 | 27,40 € |
| FZ 2.0 (15-20) | Y0FZ26ST | S/B | 77,44 € | Y0FZ26IF | 193,00 € | | | | | | | | |
| TRICITY 300 (20-22) | Y0TR30ST | U | 127,34 € | | | | | | Y0XM37RV(1) | 61,68 € | Y0XM11SC | 7 | 27,40 € |
| X-MAX 300 (17-21) | Y0XM37ST | U | 129,79 € | | | | | | Y0XM37RV(1) | 61,68 € | Y0XM11SC | 7 | 27,40 € |
| MT-03 (06-14) | | | | | | X011PS | 21,42 € | | | | | | |
| MT-03 (15-20) | Y0MT36ST | S/B | 126,95 € | Y0MT36IF | 163,01 € | X011PS | 21,42 € | D0SS5SE | | 82,14 € | | | |
| MT-03 (21) | Y0MT31ST | U | 147,57 € | Y0MT31IF | 154,92 € | | | | | | | | |
| YZF R3 (15-17) | | | | | | X011PS | 21,42 € | | | | | | |
| R3 (2017) | | | | | | X011PS | 21,42 € | | | | | | |
| MAJESTY 400 (04-06) | Y0MJ44ST | S/B | 75,00 € | | | | | | | | | | |
| MAJESTY YP 400 (10-13) | Y0MJ44ST | S/B | 75,00 € | | | | | | | | | | |
| X-MAX 400 (16-17) | Y0XM43ST | S/B | 100,66 € | | | | | | | | | | |
| X-MAX 400 (17-21) | Y0XM37ST | U | 129,79 € | | | | | | Y0XM37RV(1) | 61,68 € | Y0XM11SC | 7 | 27,40 € |
| T-MAX XP500 (01-07) | Y0T51T | S/B | 82,59 € | | | | | | | | | | |
| T-MAX XP500 / ABS (08-12) | Y0TM59ST | S/B | 143,22 € | | | | | | Y0TM52RV(1) | 49,14 € | | | |
| T-MAX 530 (12-16) | Y0TM52ST | S/B | 114,40 € | | | | | | Y0TM52RV(1) | 49,14 € | | | |
| T-MAX 530/SX SPORT/DX (17-20) | Y0TM57ST | U | 106,07 € | | | | | | | | | | |
| T-MAX 560 (20-21) | Y0TM57ST | U | 106,07 € | | | | | | | | | | |
| DIVERSION XJ 600 NS/F ABS (09-16) | Y0XJ69ST | B/A | 90,32 € | | | X011PS | 21,42 € | | | | | | |

Bike compatibility











| Make, model and year | Ref. | Plate | Price | Ref. | Price | Ref. | Price | Ref. | Ref. | Price | Ref. | Size | Price |
|--------------------------------|-----------|-------|----------|-------------|----------|--------|---------|----------|------|----------|-------------|------|----------|
| XT 660 X/R (04-16) | Y0XT64ST | S/B | 103,49 € | | | | | | | | | | |
| XT 660 Z TENERE (08-16) | | | | | | X011PS | 21,42 € | | | | | | |
| FAZER 600 (98-00) | Y0F68T | B/A | 81,54 € | | | | | | | | | | |
| FAZER 600 (01-03) | Y0FZ61ST | B/A | 96,17 € | | | | | | | | | | |
| FAZER FZ6 N/S 600 (04-06) | Y0FZ64ST | S/B | 113,95 € | | | X011PS | 21,42 € | | | | | | |
| FAZER FZ6 N/S 600 (07-11) | Y0FZ64ST | S/B | 113,95 € | | | X011PS | 21,42 € | | | | | | |
| FAZER FZ6 N/S 600 (2012) | Y0FZ64ST | S/B | 113,95 € | | | | | | | | | | |
| FZ6R R (2017) | | | | | | X011PS | 21,42 € | | | | | | |
| YZF R6 (06-18) | | | | | | X011PS | 21,42 € | | | | | | |
| MT07 (14-21) | Y0MT78ST | S/B | 163,04 € | Y0MT78IF | 176,81 € | X012PS | 26,37 € | Y0MT78SE | | 114,27 € | Y0MT71SR | | 163,23 € |
| TENERE 700 (19-22) | Y0TN79ST | B/A | 132,84 € | Y0TN794P | 234,07 € | | | | | | | | |
| TRACER 700 (16-20) | Y0MT76ST | B | 135,23 € | Y0MT76IF | 161,66 € | X011PS | 21,42 € | D0SS5SE | | 82,14 € | | | |
| | | | | Y0MT714P | 216,68 € | | | | | | | | |
| TRACER 7 (21-22) | Y0MT76ST | B | 135,23 € | Y0MT76IF | 161,66 € | X011PS | 21,42 € | D0SS5SE | | 82,14 € | | | |
| | | | | Y0MT714P | 216,68 € | | | | | | | | |
| TRACER 700 GT (19-22) | Y0TR79ST | B | 114,61 € | | | X011PS | 21,42 € | | | | | | |
| FZ07 (15-17) | | | | | | X011PS | 21,42 € | | | | | | |
| XSR 700 (16-22) | | | | | | | | Y0XS77SR | | 147,86 € | | | |
| FAZER FZ8 800 (10-15) | Y0FZ84ST | S/B | 134,86 € | | | X011PS | 21,42 € | Y0FZ80SE | | 97,60 € | | | |
| FAZER FZ8 800 (2016) | Y0FZ84ST | S/B | 134,86 € | | | | | Y0FZ80SE | | 97,60 € | | | |
| TDM 900 (2014) | | | | | | X011PS | 21,42 € | | | | | | |
| DIVERSION XJ 900 SN (94-03) | Y0XJ94ST | B | 89,90 € | | | | | | | | | | |
| FJ09 (15-17) | | | | | | X012PS | 26,37 € | | | | | | |
| MT09/STREET RALLY/FZ09 (13-16) | Y0MT93ST | B | 110,81 € | | | X011PS | 21,42 € | Y0MT97SE | | 93,13 € | | | |
| MT09 /FZ09 (17-21) | Y0MT97ST | B | 135,95 € | Y0MT97IF | 198,90 € | X011PS | 21,42 € | Y0MT97SE | | 93,13 € | | | |
| MT09 SP (18-21) | Y0MT97ST | B | 135,95 € | Y0MT98IF | 174,90 € | X011PS | 21,42 € | | | | | | |
| MT09/SP (21) | Y0MT91ST | U | 146,93 € | Y0MT91IF | 139,51 € | X011PS | 21,42 € | Y0MT91SE | | 154,92 € | Y0MT91SR(7) | | |
| NIKEN 900 (18-22) | Y0NK98ST | S/B | 120,37 € | Y0NK98IF(3) | 163,01 € | X011PS | 21,42 € | | | | | | |
| TRACER 900 (15-17) | Y0MT95ST | B | 98,85 € | Y0MT95IF | 159,76 € | X012PS | 26,37 € | | | | | | |
| TRACER 900 /GT (18-20) | Y0TC98ST | U | 145,88 € | Y0TC98IF(3) | 173,84 € | X012PS | 26,37 € | Y0TR98SE | | 123,96 € | | | |
| | | | | Y0TR984P | 209,07 € | | | | | | | | |
| TRACER 9/GT (21-22) | *Y0TR91ST | U | 146,21 € | Y0TR91IF(3) | 213,98 € | X012PS | 26,37 € | Y0TR91SE | | 150,05 € | | | |
| | Y0TC91ST | U | 153,03 € | | | | | | | | | | |
| XSR 900 (16-22) | | | | | | X011PS | 21,42 € | | | | | | |
| MT10 / FZ1 | | | | | | | | | | | | | |

SPORT BAGS

| | Ref. | Description | Measurements | Price | Qty x masterbox | |
|---|---------------|-------------|---------------------------|-------------------------|-----------------|----|
|  | E04 | X0SE04 | Semi rigid small tank bag | 3L / 29 26x10 cm | 69,90 € | 10 |
|  | E22 | X0SE22 | Semi rigid tank bag | 16-22L / 42x30x22 cm | 110,00 € | 5 |
|  | NEW E48 2U. | X0SE481 | Semi rigid saddle bags | 46-58L / 47x24/30x29 cm | 149,00 € | 4 |
|  | NEW E48SR 2U. | X0SE48SR | Hard shell saddle bags | 30L / 45x27x29 cm | 339,00 € | 1 |

TOURING BAGS



| | Ref. | Description | Measurements | Price | Qty x masterbox | |
|---|---------|-------------|---------------------------|-------------------------|-----------------|-----|
|  | SL58 2U | X0SL58 | Big saddle bags | 46-58 L / 18-25x47x29cm | 139,90 € | 2 |
|  | SL20F | X0SL20F | Tank bag -straps fastener | 15-20 L / 18-21x30x40cm | 79,00 € | 4 |
|  | SL12M | X0SL12M | Small tank bag-magnets | 4 L / 10x30x19cm | 55,00 € | 15 |
|  | SL86 | X0SL86 | Backpack bag | 26 L / 27x30x45cm | 69,90 € | 5 |
|  | SL05 | X0SL05 | Big leg bag | 2 L / 11x25x15cm | 30,90 € | 32 |
|  | SL04 | X0SL04 | Small leg bag | 0,5 L / 3x26x13cm | 19,90 € | 80 |
|  | SL03 | X0SL03 | Waist bag | 3 L / 9x23x16cm | 37,29 € | 20 |
|  | SL01 | X0SL01 | Toll pass pouch | 4x6x10cm | 10,90 € | 200 |
|  | SC25 | X0SC25 | Scooter bag | 25 L / 38x26x27 cm | 64,90 € | 10 |

| Ref. | Accessories For Soft Bags: Description | Price | Qty x box |
|--------|--|---------|-----------|
| X1SB11 | Magnets (2 u.): SB25, SB22, SB15 | 11,25 € | - |
| X1SL11 | Magnets (4 u.): SL35/SL23/SL20/SL12 | 25,90 € | 40 |
| X1SB97 | Thermo Pad E48/SL58/SB50/SB60 | 27,00 € | 25 |
| X1SL90 | Universal Base Tank: SL35/SL23/SL20/SL12 | 20,15 € | 45 |

| Ref. | Accessories For Soft Bags: Description | Price | Qty x box |
|--------|--|---------|-----------|
| X1SL09 | Straps for Tank Bag | 6,59 € | - |
| X1SL01 | Rain cover for small tank bags | 10,90 € | 100 |
| X1SL02 | Film protector | 4,94 € | - |
| X0IB08 | Small Duffle Bag | 10,29 € | 50 |







* until stock ends

PIN SYSTEMS BAGS



| | Ref. | Description | Litres / Mesures | Price | Qty x masterbox | |
|---|------|-------------|--------------------------------|----------------------------|-----------------|----|
|  | E04P | X0SE04P | Semi rigid pin system tank bag | 3L / 29x26x10 cm | 79,00 € | 12 |
|  | E10P | X0SE10P | Semi rigid pin system tank bag | 5L / 31x22x15 cm | 94,50 € | 8 |
|  | E16P | X0SE16P | Semi rigid pin system tank bag | 11 to 15L / 28x40x20/26 cm | 114,50 € | 4 |

ADVENTURE BAGS

100% WATERPROOF

| | Ref. | Description | Measurements | Price | Qty x masterbox | |
|---|----------|-------------|-----------------|----------------|-----------------|----|
|  | SW22 | X0SW22 | Tank Bag | 13L / 37x19x17 | 99,90 € | 10 |
|  | SW23 | X0SW23B | Tank Bag | 14L / 35x26x24 | 129,90 € | 4 |
|  | SW38 | X0SW38 | Rear duffle bag | 35L / 54x28 | 79,90 € | 15 |
|  | SW42 2U. | X0SW42 | Saddle bags | 50L / 42x34x17 | 199,90 € | 3 |
|  | SW45 | X0SW45 | Rear backpack | 40L / 48x31x17 | 149,90 € | 10 |
|  | IB20 | X0IB20 | Duffle Bag | 20L / 54x24x3 | 19,42 € | 25 |

CAFE RACER BAGS

| | Ref. | Description | Measurements | Price | Qty x masterbox | |
|---|----------|-------------|--------------|-------------------|-----------------|---|
|  | SR18 | X0SR18 | Tank Bag | 8L / 36x18x15 cm | 84,90 € | 9 |
|  | SR28 | X0SR28 | Rear bag | 27L / 40x26x25 cm | 164,90 € | 4 |
|  | SR38 1U. | X0SR38 | Saddle bag | 10L / 34x15x24 cm | 114,90 € | 6 |

BACKRESTS

| Colour | Ref. | Price | Colour | Ref. | Price | Colour | Ref. | Price | Colour | Ref. | Price |
|--------|--------|---------|--------|--------|---------|--------|--------|---------|--------|---------|---------|
| Black | D0RP00 | 57,66 € | Grey | D0RP05 | 57,66 € | White | D0RP08 | 57,66 € | Black | D0RP00N | 57,66 € |



SPECIFIC BACKREST SUPPORT SOLD SEPARATELY

RAIN JACKETS SRP 2022

| Size | Cm | Ref. | Price | Qty x masterbox |
|------|------|-----------|---------|-----------------|
| S | 57 | X0SR55S | 50,00 € | 40 |
| M | 59,5 | X0SR55M | | |
| L | 62 | X0SR55L | | |
| XL | 64,5 | X0SR55XL | | |
| XXL | 67 | X0SR55XXL | | |
| 3XL | 69,5 | X0SR553XL | | |



RAIN PANTS

| Size | Cm | Ref. | Price | Qty x masterbox |
|------|------|-----------|---------|-----------------|
| S | 34 | X0SR20S | 25,00 € | 40 |
| M | 36,5 | X0SR20M | | |
| L | 39 | X0SR20L | | |
| XL | 41,5 | X0SR20XL | | |
| XXL | 44 | X0SR20XXL | | |
| 3XL | 46,5 | X0SR203XL | | |



HAND MUFFS

| Ref. | Price | Qty x masterbox |
|--------|---------|-----------------|
| X0SR00 | 49,90 € | 10 |



SMARTPHONE HOLDERS

| | Ref. | Description | Max. Phone Size | Price | Qty x masterbox |
|--|----------|-------------------------------|-----------------|---------|-----------------|
| | X0SG62H | Smartphone holder | 16x8 | 49,99 € | 30 |
| | X0SG71H | Smartphone holder | 18x9 | 49,99 € | 30 |
| | X0SG76H | Smartphone holder with pocket | 18x9 | 49,99 € | 30 |
| | X0SG00H | X-frame | 18x9 | 39,90 € | 45 |
| | *X0SG20H | Smartphone holder | 6x12 | 37,85 € | 20 |
| | X0SG62M | Smartphone holder | 16x8 | 49,99 € | 30 |
| | X0SG71M | Smartphone holder | 18x9 | 49,99 € | 30 |
| | X0SG76M | Smartphone holder with pocket | 18x9 | 49,99 € | 30 |
| | X0SG00M | X-frame | 18x9 | 39,90 € | 45 |

| Ref. | Spare Parts Smartphone holders | Price |
|---------|--------------------------------|---------|
| 203966R | Handlebar fitting | 7,74 € |
| 203967R | Mirror fitting | 15,73 € |

| Ref. | Spare Parts Smartphone holders | Price |
|---------|--------------------------------|--------|
| X1SGMAR | Mirror adapter | TBC |
| 203884R | Safety Net | 3,39 € |

ATV CASES

ATV110



| Ref. | Description | Price |
|----------------|----------------|-----------------|
| D0Q1100 | | 309,00 € |
| 200537R | Locking system | 17,05 € |
| D1TV80R | Handle | 22,24 € |
| D1BQ8CAR | Reflector | 11,08 € |
| D0RI50 | Backrest | 32,24 € |
| S1Q8BOR | Screw set | 31,97 € |
| D1Q11ETR | Stickers | 12,67 € |
| 201528R | Lid stop strap | 10,54 € |
| 200035R | Spring | 0,60 € |

ATV80



| Ref. | Description | Price |
|---------------|----------------|-----------------|
| S0Q800 | | 349,00 € |
| 200451R | Locking system | 17,34 € |
| D1TV80R | Handle | 22,24 € |
| D1BQ8CAR | Reflector | 11,08 € |
| D0RI50 | Backrest | 32,24 € |
| S1Q8BOR | Screw set | 31,97 € |
| 500545R | Stickers | 12,24 € |
| 200452R | Lid stop strap | 14,09 € |
| 200035R | Spring | 0,60 € |

ATV40



| Ref. | Description | Price |
|---------------|----------------|--------------|
| D0Q200 | | 179 € |
| 200537R | Locking syst | 17,05 € |
| S1Q8BOR | Screw set | 31,97 € |
| 500545R | stickers | 12,24 € |
| 201481R | Lid stop strap | 21,36 € |

COMFORT SEATS

| Make, model and year | Ref. | Description | Price |
|--|------------|-----------------------------|----------|
| KAWASAKI | | | |
| Z750 (07-13) / Z1000 (07-09) | SHK0Z1000C | BLACK, with DARK GREY seams | 280,80 € |
| YAMAHA | | | |
| T.MAX 500/530 (08-16) | SHY0T5320 | BLACK, with WHITE seams | 280,80 € |
| FAZER FZ6 600 (04-10) | SHY0F7000 | BLACK, with GREY seams | 251,16 € |
| MT 09 (13-18) | SHY0M9300 | BLACK, with GREY seams | 280,80 € |
| PIAGGIO | | | |
| MP3 RL (07-12) / MP3 RST 125-250-100 (09-12) / MP3 LT 250-400 (09-13) MP3 500 SPORT/ BUSINESS (11-13) | SHV0M2320 | BLACK, with GREY-BLUE seams | 310,96 € |
| HONDA | | | |
| CBR600F (2011-12) * | SHH0B6200 | BLACK, with GREY seams | 260,00 € |
| | *SHH0B6209 | BLACK, with RED seams | |
| | *SHH0B6201 | BLACK, with BLUE seams | |

* Until stock ends

SHAD LOCKS

| | Ref. | Description | Size | Measures | Price | Qty x master box |
|--|---------|-------------|------|---------------|---------|------------------|
| | SERIE 3 | C0S303H | 3 | 39x 4,4x3,8 | 48,00 € | 12 |
| | | C0S305H | 5 | 44,5x 4,4x3,8 | 49,00 € | |
| | | C0S307H | 7 | 50x4,4x3,8 | 50,00 € | |
| | SERIE 2 | C0S203H | 3 | 39x 4,4x3,8 | 31,50 € | |
| | | C0S205H | 5 | 44,5x 4,4x3,8 | 32,50 € | |
| | | C0S207H | 7 | 50x4,4x3,8 | 33,50 € | |

WHY SHAD



reddot winner 2021



TERRA

TERRA SET / TR48 TR36 TR47



DESIGN IN BARCELONA

Since 1973

SINCE
1973



1.-WE MANUFACTURE FOR THE TOP BRANDS

The SHAD brand is part of NAD SL, a company with almost 50 years of experience, the market leader for OEM manufactures of motorcycle seats and cases for top brands such as BMW, Triumph, KTM, Honda, ...

2.- THE MOST DESIGN AWARDED MOTORCYCLE CASES

The eXpandable cases SH58X/SH59X won the Red Dot Design Award 2017; the SH36 side cases won the Red Dot 2015 as well as the German Design Award 2017. In recent years, SHAD has achieved various international design awards for the Terra cases, Expandable top cases and the SH36 side case. Awards that reinforce our market position that our brand is achieving in terms of design and functionality for riders.



PATENT

3.- INNOVATION

Our commitment to R&D has brought to the market many innovative solutions: eXpandable top cases, 3P system & 4P System, Pin system tank bags and all of our locking systems.



4.- DESIGNED IN BARCELONA

All of our products are entirely designed and developed at our Barcelona headquarters. Moreover, we have a various production centers located in the Barcelona area.



5.-GROWING WORLDWIDE PRESENCE

Present in 5 continents, we distribute our products to more than 80 countries.



6.-SOCIAL & ENVIRONMENTAL RESPONSIBILITY

We focus on promoting a responsible production processes, we take care to do our part to protect the planet and giving a helping hand to a global network everywhere we operate.



7.-WARRANTY & QUALITY

All our products are subjected to exhaustive quality controls and have a warranty period according to local legislation; as long as the recommendations for use and assembly indicated by SHAD are respected.

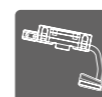

8.- RESISTANT & LIGHTWEIGHT FITTINGS

We create fitting systems adapted to different types of motorcycles and their use. Systems that are visually integrated on the motorcycle and ensure the strongest and safest solutions.



9.-COMFORT & EASY USE

Our cases are designed to be carried around easily. In addition, our locking systems can be operated with one hand.



10.- TOP CASE MOUNTING

Most of our top cases include the mounting plate and screw set to be installed in an easy and comfortable way. For Terra top cases, there are 3 mounting plate options available.



OUR CUSTOMERS

Every day we take on new technical and design challenges to maintain the trust of our customers.



THE COMPANY

SHAD ENGINEERED FOR RIDING

NAD, founded in 1973 and owner of the SHAD brand, is a leader in the manufacture of seats and cases for the main manufacturers in the motorcycle industry.

This year we are celebrating 30 years of SHAD in the market, and we reaffirm our commitment to innovation. On this anniversary we want to thank our team of collaborators, suppliers and, especially our customers, for the trust and support they have always given to us.

Focusing on engineering and design, we will continue to offer solutions in more than 80 countries. This year we confirm NAD-SHAD's commitment to the "ADVENTURE" sector, after a year in which our range of TERRA aluminum cases has been recognized with prestigious international design awards.



Present in **80** countries

2021 Figures
+ 5000 points of sale
+ 900.000 products sold



CIAO
HOLA



ENGINEERED FOR RIDING

DESIGN IN BARCELONA
Since 1973

RESEARCH



IDEATION

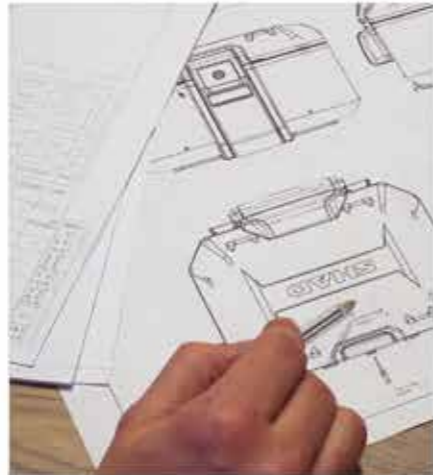

PROTOTYPING



TESTING



IMPLEMENTATION



3P SYSTEM
2015
PATENTED

3 points fitting kit. Integration, lightness and flexibility.



GERMAN DESIGN AWARD 2017
reddot design award winner 2015
SIDE CASES SH36

EXPANDABLE
2016
PATENTED

Adjustment of the top case volume. Capacity and Aerodynamics.



reddot design award winner 2017
EXPANDABLE CASES
SH36X SH36X

Pin System
2017
PATENT PENDING

Integrated and multiadaptable fitting mechanism.



SHAD TERRA
2018
PATENT PENDING



reddot winner 2021
DESIGN AWARD 2021
ABC INTELLECTUAL PROTECTION

SHADLOCKS
ENGINEERED FOR RIDING
2021
PATENT PENDING

Set of patents to protect the intellectual property of this product



SHAD TERRA
2022
PATENT PENDING

Practical and secure double locking system



TR40

Our strategic approach is based on engineering and design. We kickoff the development process of SHAD products starting with the analysis of market trends and base them according to the needs of our customers.

Our creation process is finalized after an exhaustive period of numerous laboratory tests and prototypes.

Bringing together design and engineering, coupled with almost 50 years of experience in the sector, has allowed us to:

- Create innovative SHAD products for the main brands in the sector.
- Obtain a set of patented products to technically differentiate us from the rest.
- Win important international design awards.

- Distribute our product to more than 80 countries.
- Participate in exhibitions and fairs worldwide.
- Be championship sponsors of SUPERBIKES.

For NAD-SHAD, innovation is a way of life and a commitment that we maintain.

CIAO HOLA



QUALITY CASES LAB

Quality

The quality of our products is based on continuous improvement, excellence in management and customer satisfaction. We test the product throughout the whole production and development process both in external and our own spe-

cialized laboratories, guaranteeing compliance with rigorous quality standards, checking every detail, from the raw material to the final product to be delivered to the customer.



PAINT ADHERENCE TEST

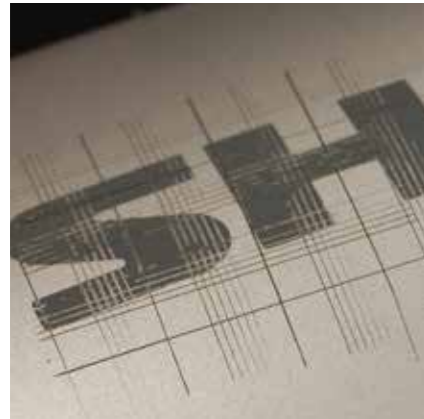

SHAKER TEST

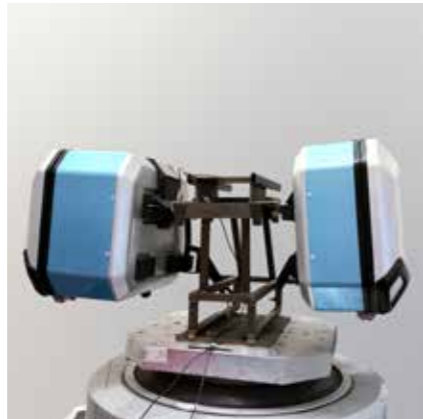

WATERPROOF TEST



WEATHERING TEST



TRACTION TEST



IMPACT TEST



CIAO HOLA



RESOURCE REDUCTION (per year):

- 60000 pages of paper (A4) (277.5Kg)
- 17.3 TONS of iron
- 6.7 TONS of plastic
- 47.8 TONS CO2

ISO 14001:2015 RAW MATERIALS COMPLY WITH ENVIRONMENTAL REGULATIONS

- 100% from wind power
- 100% cleaning products EU Ecolabel
- 100% Electric forklifts
- 100% LED lighting in production centres
- Free Electric vehicles charging points in HQ
- 100% Water based glues in seats production
- 100% Ecological dismoulding Spray for seats production
- 50-50% Recyclable and Reusable packaging For OEM projects
- 15% Energetic Savings in our factories
- 900 trees planted in our SHAD forest

OUR FUTURE IS ALSO GREEN

- NEW INTELLIGENT WAREHOUSE
- 100% Self-sustaining factory (Solar panels, Natural Lighting, Skylight fans)
- 2000 trees in our SHAD forest (2000 > 2025)
- 30% Autoproduced Solar Energy in HQ by 2022
- 5,7 t./year paper reduction by 2022 due to digital user manuals
- 100% Paper free invoicing by 2022



JUST ENTER AND SEE HOW



SOCIAL RESPONSIBILITY AND COLLABORATION

ENVIRONMENTAL

ISO 14001: 2015 

 tree-nation

Tree-Nation is an open, collaborative platform to reforest the world.

INDUSTRY (CLUSTERS)

 BCD
Barcelona Centre de Disseny

 anesdor

 clustermoto

SOCIAL APPROACH & COMMUNITY

 Collaboration with local events and associations

 Cruz Roja

 unicef

 CLUB BASQUET MOLLET

SPONSORSHIPS



f @SHAD.Motorcycle.Cases
i @Shad_motorcycle_cases
v SHAD Motorcycle cases



@alessio.mothotherapy



@blackoleum



@guidobasso



@riding_with_god



@motoaddicted_



@roby_katia_ontheroad



@cadaunosumoto



@motoaddicted_



@Maharidikamotovlog



@ridetobe



@frene_mt



@motoaddicted_



@ivanma_bcn



@Wanderer.ankit



@math_advrider

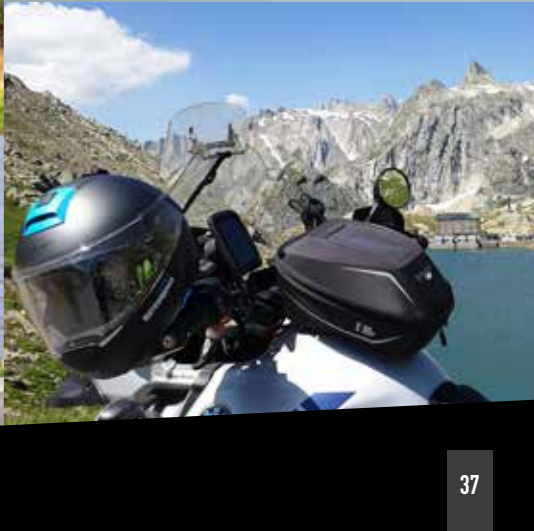

TERRA
BLACK EDITION
ALUMINIUM CASES

SHAD
TERRA
ENGINEERED FOR RIDING



TERRA SET / **TR48 TR36 TR47** BLACK EDITION

MORE INFO



SHAD TERRA

ENGINEERED FOR RIDING



reddot winner 2021



TERRA LOCK SYSTEM PATENT PENDING

AISI 304
STAINLESS STEEL
INTEGRATED LOCK SYSTEM

INTEGRATED CARRYING HANDLE



HARDENED ALUMINIUM ALLOY:
MAXIMUM RESISTANCE &
MINIMUM WEIGHT



LOCK SYSTEM

DOUBLE LOCKING PATENTED SYSTEM: QUICK & EASY TO INSTALL AND REMOVE

1 Key and 1 hand for all operations, place, remove, open and close.



CAPACITY

UP TO TWO HELMET CAPACITY



PREMIUM KEY

+ ANTIDUST PROTECTOR



SIDE OPENING

QUICK AND EASY ACCESS TO STORE YOUR BELONGINGS



DETAILS

EXTRA CARGO HOOKS



STAINLESS STEEL HINGES



RETRACTABLE FOLDING TRAY



INNER CARPET FOR TOP CASES



TR48

X49,5 Y41,8 Z32,2 (cm)
Ref. D0TR48100

PATENT PENDING



PATENT PENDING



reddot winner 2021



TR48

BLACK EDITION
ALUMINIUM CASES
X49,5 Y41,8 Z32,2 (cm)
Ref. D0TR48100B



FEATURES



Icons description Page 130

ACCESSORIES

BACKREST
Ref. D0RI75



INNER BAG EXPANDABLE
Top - Side
Ref. X0IB47



REQUIRED

OPTION 1

ALUMINIUM PLATE + SCREWS
D1BTRPA



OPTION 2

ALUMINIUM PLATE + SCREWS
D1BTRPA2



OPTION 3

BIG PLATE + SCREWS
D1B591PA



FEATURES



Icons description Page 130

ACCESSORIES

BACKREST
Ref. D0RI75



INNER BAG EXPANDABLE
Top - Side
Ref. X0IB47



REQUIRED

OPTION 1

ALUMINIUM PLATE + SCREWS
D1BTRPA



OPTION 2

ALUMINIUM PLATE + SCREWS
D1BTRPA2



OPTION 3

BIG PLATE + SCREWS
D1B591PA



TR37

X49,5 Y41,8 Z25,9 (cm)
REF. D0TR37100

PATENT PENDING



PATENT PENDING



reddot winner 2021



DESIGN AWARD 2021



ABC SPECIAL MENTION 21

TR37

BLACK EDITION

ALUMINIUM CASES

X49,5 Y41,8 Z25,9 (cm)
Ref. D0TR37100B



FEATURES



Icons description Page 130

ACCESSORIES

BACKREST
Ref. D0RI75



INNER BAG EXPANDABLE
Top - Side
Ref. X0IB47



REQUIRED

OPTION 1

ALUMINIUM PLATE + SCREWS

D1BTRPA



OPTION 2

ALUMINIUM PLATE + SCREWS

D1BTRPA2



OPTION 3

BIG PLATE + SCREWS

D1B591PA



FEATURES



Icons description Page 130

ACCESSORIES

BACKREST
Ref. D0RI75



INNER BAG EXPANDABLE
Top - Side
Ref. X0IB47



REQUIRED

OPTION 1

ALUMINIUM PLATE + SCREWS

D1BTRPA



OPTION 2

ALUMINIUM PLATE + SCREWS

D1BTRPA2



OPTION 3

BIG PLATE + SCREWS

D1B591PA



TR47L
BLACK EDITION
 ALUMINIUM CASES
 X49,5 Y41,8 Z34,5 (cm)
 Ref. LEFT D0TR47100LB



PATENT PENDING



PATENT PENDING



reddot winner 2021



TR47R
BLACK EDITION
 ALUMINIUM CASES
 X49,5 Y41,8 Z34,5 (cm)
 Ref. RIGHT D0TR47100RB



FEATURES



Icons description Page 130

FEATURES



Icons description Page 130

ACCESSORIES

OPTIONAL INNER MESH
 FOR SIDE CASE
 Ref. X0TR01



RETRACTABLE TRAY
 INCLUDED

OPTIONAL INNER BAG
 INNER BAG / EXPANDABLE
 Ref. TOP - SIDE X0IB47

ACCESSORIES



RETRACTABLE TRAY
 INCLUDED

OPTIONAL INNER BAG
 INNER BAG / EXPANDABLE
 Ref. TOP - SIDE X0IB47

REQUIRED

LOCK CYLINDERS + KEYS

NOT INCLUDED
 REF. D1TRB0R



WARNING! ⚠

LOCK CYLINDER + KEYS NOT INCLUDED

INCLUDED

INNER MESH



LOCK CYLINDERS + KEYS



TR47L

X49,5 Y41,8 Z34,5 (cm)
Ref. LEFT D0TR47100L



PATENT PENDING



PATENT PENDING



reddot winner 2021



DESIGN AWARD 2021



SPECIAL MENTION '21

TR47R

X49,5 Y41,8 Z34,5 (cm)
Ref. RIGHT D0TR47100R



FEATURES



Icons description Page 130

FEATURES



Icons description Page 130

ACCESSORIES

OPTIONAL INNER MESH
FOR SIDE CASE
Ref. X0TR01



RETRACTABLE TRAY
INCLUDED

OPTIONAL INNER BAG
INNER BAG / EXPANDABLE
Ref. TOP - SIDE X0IB47

REQUIRED

LOCK CYLINDERS + KEYS

NOT INCLUDED
REF. D1TRB0R



WARNING! ⚠

LOCK CYLINDER + KEYS NOT INCLUDED

ACCESSORIES



RETRACTABLE TRAY
INCLUDED

OPTIONAL INNER BAG
INNER BAG / EXPANDABLE
Ref. TOP - SIDE X0IB47

INCLUDED

INNER MESH



LOCK CYLINDERS + KEYS



TR36L

BLACK EDITION

ALUMINIUM CASES

X49,5 Y41,8 Z28,2 (cm)

Ref. LEFT D0TR36100LB

PATENT PENDING



PATENT PENDING



reddot winner 2021



TR36R

BLACK EDITION

ALUMINIUM CASES

X49,5 Y41,8 Z28,2 (cm)

Ref. RIGHT D0TR36100RB



FEATURES



Icons description Page 130

FEATURES



Icons description Page 130

ACCESSORIES

OPTIONAL INNER MESH
FOR SIDE CASE
Ref. X0TR01



RETRACTABLE TRAY
INCLUDED

OPTIONAL INNER BAG
INNER BAG / EXPANDABLE
Ref. TOP - SIDE X0IB47

ACCESSORIES



RETRACTABLE TRAY
INCLUDED

OPTIONAL INNER BAG
INNER BAG / EXPANDABLE
Ref. TOP - SIDE X0IB47

REQUIRED

LOCK CYLINDERS + KEYS

NOT INCLUDED
REF. D1TRB0R



WARNING! ⚠

LOCK CYLINDER +
KEYS NOT INCLUDED

INCLUDED

INNER MESH



LOCK CYLINDERS + KEYS



TR36L

X49,5 Y41,8 Z34,5 (cm)
Ref. LEFT D0TR47100L



PATENT PENDING



PATENT PENDING



reddot winner 2021



TR36R

X49,5 Y41,8 Z34,5 (cm)
Ref. RIGHT D0TR47100R



FEATURES



Icons description Page 130

FEATURES



Icons description Page 130

ACCESSORIES

OPTIONAL INNER MESH
FOR SIDE CASE
Ref. X0TR01



RETRACTABLE TRAY
INCLUDED

OPTIONAL INNER BAG
INNER BAG / EXPANDABLE
Ref. TOP - SIDE X0IB47

ACCESSORIES



RETRACTABLE TRAY
INCLUDED

OPTIONAL INNER BAG
INNER BAG / EXPANDABLE
Ref. TOP - SIDE X0IB47

REQUIRED

LOCK CYLINDERS + KEYS

NOT INCLUDED
REF. D1TRB0R



WARNING! ⚠

LOCK CYLINDER +
KEYS NOT INCLUDED

INCLUDED

INNER MESH



LOCK CYLINDERS + KEYS



HOW TO BUY YOUR TERRA CASE

TOP CASE

1 CHOOSE YOUR TERRA CASE

SIDE CASE

1 CHOOSE YOUR TERRA RIGHT CASE

TR48 TR37



TR37 TR48
BLACK EDITION BLACK EDITION



TR47R TR36R



TR47R TR36R
BLACK EDITION BLACK EDITION



2 CHOOSE YOUR MOUNTING PLATE

2 CHOOSE YOUR TERRA LEFT CASE

ALUMINIUM PLATE + SCREWS

D1BTRPA



D1BTRPA2



BIG PLATE + SCREWS

D1B591PA



TR36L TR47L



TR36L TR47L
BLACK EDITION BLACK EDITION



3 CHOOSE YOUR TOP MASTER

3 CHOOSE YOUR 4P SYSTEM

Bike compatibility



WATCH OUT
EXHAUST PIPE
SIDE
Always TR36

Bike compatibility



4P
SYSTEM



NEW TR40

X40 Y25 Z38 (cm)
Ref. X0TR401

PATENT PENDING



INCLUDED

DRY BAG + BAG HOLDER FUEL BOTTLE HARNESS



DETAILS

4 SIDE + 2 TOP DURAFLEX CAMBUCKLES ADJUST THE BAG TO THE SIZE OF THE LOAD

AIRCRAFT GRADE ANODIZED ALUMINUM BUCKLES

REFLECTIVE ELEMENTS

2 MOLLE SYSTEM GRIDS PER BAG



FEATURES

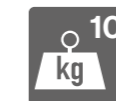

Icon descriptions Page 130

PATENT PENDING

DOUBLE LOCKING SYSTEM

QUICK MOUNTING & QUICK LOCKING: ONE KEY TO OPEN AND RELEASE. LOCK ACCESS TO INSIDE OF THE BAG



PREMIUM LOCK

+ ANTIDUST PROTECTOR



ULTRA DURABLE MATERIAL

1500h UV protection

Abrasion resistance **50.000 cycles**

Reinforced stitching

Reinforced bottom structure

WATERPROOF

DOUBLE ROLL BAGS: OUTER BAG AND INCLUDED INNER BAG ENSURES WATER-PROOFNESS



INSTALLATION TO 4P SYSTEM

HEAVY DUTY 4P MOUNTING PLATE MADE OF POLYAMIDE 30% GLASS FIBER



SIDE FITTING not included



+ info Page 96

TOP CASES



reddot design award
winner 2017

THE MOST DESIGN-AWARDED MOTORCYCLE CASES



EXPANDABLE CASE

MAXIMUM VERSATILITY



PATENTED



reddot design award
winner 2017

DESIGNED & MADE IN BARCELONA

Since 1973



TESTED IN MOROCCO HONDA EPIC TOUR

MOTODYNAMICS



EASY TO EXPAND

3 POSITIONS:

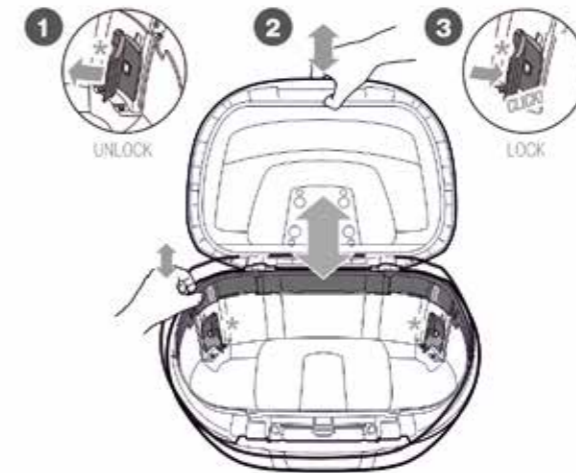

Transform in seconds from a large case to a small aerodynamic one

FEATURES

STRUCTURAL FRAME

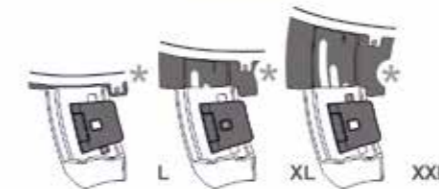
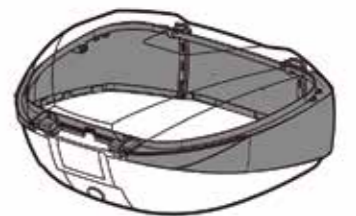

SH59X

X48 Y61 Z27/29/31.5 (cm)
Ref. D0B59200

PATENTED



reddot design award
winner 2017



EXPANDABLE CASE



DAILY



WEEKEND



HOLIDAYS



FEATURES



Icons description Page 130

INCLUDED

STANDARD PLATE

PREMIUM SMART LOCK



ACCESSORIES

BACKREST
Ref. DORI80



INNER BAG
Ref. X0IB10



X 21/29 Y 53 Z 34 (cm)
EXPANDABLE

ALUMINIUM PLATE +
SCREWS
Ref. D1BTRPA



ALUMINIUM PLATE +
SCREWS
Ref. D1BTRPA2



BRAKE LIGHT
Ref. D0B29KL



LED

SH58X

X48 Y61 Z27/29/31.5 (cm)
Ref. D0B58206

PATENTED



red dot design award
winner 2017



EXPANDABLE CASE



L

DAILY



XL

WEEKEND



XXL

HOLIDAYS

CARBON
Ref. D0B58206



NEW TITANIUM
Ref. D0B58206 +
D1B58E15



WHITE
Ref. D0B58206 +
D1B58E08



BLACK METAL
Ref. D0B58206 +
D1B58E21



BACKREST
Ref. DORI80



INNER BAG
Ref. X0IB10



X 21/29 Y 53 Z 34 (cm)
EXPANDABLE

ACCESSORIES

ALUMINIUM PLATE +
SCREWS
Ref. D1BTRPA



ALUMINIUM PLATE +
SCREWS
Ref. D1BTRPA2



BRAKE LIGHT
Ref. D0B29KL



LED

FEATURES



Icons description Page 130

INCLUDED

STANDARD PLATE



PREMIUM SMART LOCK



SH50

X46 Y60 Z32 (cm)
Ref. D0B5000



BLACK
Ref. D0B5000



WHITE
Ref. D0B5000 + D1B50E08



UNPAINTED COVER
Ref. D1B50ER

BLUE
Ref. D0B5000 + D1B50E01



RED
Ref. D0B5000 + D1B50E09



SILVER
Ref. D0B5000 + D1B50E05



BLACK METAL
Ref. D0B5000 + D1B50E21



FEATURES



Icons description Page 130

INCLUDED

STANDARD PLATE



BACKREST



ACCESSORIES

INNER BAG
Ref. X0IB00



X 35 Y 50 Z 21 (cm)

LUGGAGE RACK
Ref. D0PS00



BRAKE LIGHT
Ref. D0B29KL



LED

SH48

DARK GREY

X46 Y61 Z31 (cm)
The lightest in its range
Ref. D0B48306R



DARK GREY
Ref. D0B48300 [no cover]



CARBON
Ref. D0B48300 + D1B48E06



CARBON + BACKREST
Ref. D0B48306R



WHITE
Ref. D0B48300 + D1B48E08



DARK GREY
Ref. D0B48300 + D1B48E17



BLACK METAL
Ref. D0B48300 + D1B48E21



FEATURES



Icons description Page 130

INCLUDED

STANDARD PLATE



PREMIUM SMART LOCK



ACCESSORIES

BACKREST
Ref. D0RI4800



INNER BAG
Ref. X0IB00



X 35 Y 50 Z 21 (cm)

LUGGAGE RACK
Ref. D0PS00



ALUMINIUM
PLATE + SCREWS
Ref. D1BTRPA



ALUMINIUM
PLATE + SCREWS
Ref. D1BTRPA2



BRAKE LIGHT
Ref. D0B29KL



LED

SH48

NEW TITANIUM

X46 Y61 Z31 (cm)
The lightest in its range
Ref. D0B48406R



NEW TITANIUM
Ref. D0B48400 [no cover]



CARBON
Ref. D0B48400 + D1B48E06



CARBON + BACKREST
Ref. D0B48406R



WHITE
Ref. D0B48400 + D1B48E08



NEW TITANIUM
Ref. D0B48400 + D1B48E15



BLACK METAL
Ref. D0B48400 + D1B48E21



FEATURES



Icons description Page 130

INCLUDED

STANDARD PLATE PREMIUM SMART LOCK



ACCESSORIES

BACKREST
Ref. D0R14800



INNER BAG
Ref. X0IB00



X 35 Y 50 Z 21 (cm)

LUGGAGE RACK
Ref. D0PS00



ALUMINIUM PLATE + SCREWS
Ref. D1BTRPA2



BRAKE LIGHT
Ref. D0B29KL



LED

SH47

RED

X42 Y57,5 Z31,2 (cm)
Ref. D0B47206



SH47

WHITE

X42 Y57,5 Z31,2 (cm)
Ref. D0B47106



FEATURES



Icons description Page 130

INCLUDED

STANDARD PLATE



ACCESSORIES

INNER BAG
Ref. X0IB00



X 35 Y 50 Z 21 (cm)

BACK REST
Ref. D0RI47



BRAKE LIGHT
Ref. D0B40KL



LED

COLOUR COVERS
Ref. D1B47E...

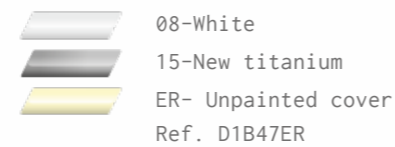

Ref. D1B47ER

FEATURES



Icons description Page 130

INCLUDED

STANDARD PLATE



ACCESSORIES

INNER BAG
Ref. X0IB00



X 35 Y 50 Z 21 (cm)

BACK REST
Ref. D0RI47



LIGHT
Ref. D0B40KL



LED

COLOUR COVERS
Ref. D1B47E...

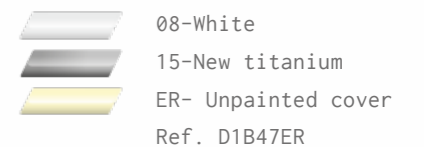

Ref. D1B47ER

SH46

X42 Y58 Z31 (cm)
Ref. D0B46200



FEATURES



Icons description Page 130

INCLUDED

STANDARD PLATE



ACCESSORIES

BACKREST
Ref. D0RI50



INNER BAG
Ref. X0IB00



X 35 Y 50 Z 21 (cm)

LUGGAGE RACK
Ref. D0PS00



BRAKE LIGHT
Ref. D0B40KL



LED

SH45

X41 Y56.4 Z31.4 (cm)
Ref. D0B45100 + D1B45E05



FEATURES



Icons description Page 130

INCLUDED

STANDARD PLATE



ACCESSORIES

BACKREST
Ref. D0RI60



INNER BAG
Ref. X0IB00





X 35 Y 50 Z 21 (cm)

BRAKE LIGHT
Ref. D0B40KL



LED

No cover top case Ref. D0B45100
COLOUR COVERS
Ref. D1B45E...

-  01-Blue
-  05-Silver
-  08-White
-  09-Red
-  21-Black

NEW SH44

X43,5 Y55 Z31,5 (cm)
Ref. D0B44100



FEATURES



Icons description Page 130

INCLUDED

STANDARD PLATE



ACCESSORIES

BACKREST
Ref. D0RI60



BRAKE LIGHT
Ref. D0B40KL



LED

INNER BAG
Ref. X0IB00



X 35 Y 50 Z 21 (cm)

SH40

X42,5 Y49,5 Z29,6 (cm)
Ref.: D0B40100+D1B40E08



Alu look top case.
Ref. D0B40200



FEATURES



Icons description Page 130

INCLUDED

STANDARD PLATE



ACCESSORIES

BACKREST
Ref. D0RI60









BRAKE LIGHT
Ref. D0B40KL



LED

No cover top case Ref. D0B40100
COLOUR COVERS
Ref. D1B40E...

-  01-Blue
-  05-Silver
-  08-White
-  09-Red
-  21-Black
-  Unpainted Cover
Ref. D1B40ER

SH40

CARGO

X42.5 Y49.2 Z32.5 (cm)
Ref. D0B40199



FEATURES



Icons description Page 130

INCLUDED

STANDARD PLATE



ACCESSORIES

BACKREST
Ref. D0RI60



BRAKE LIGHT
Ref. D0B40KL



LED

SH39

X43 Y51 Z32 (cm)
Ref. D0B39106



FEATURES



Icons description Page 130

INCLUDED

STANDARD PLATE



ACCESSORIES

BACKREST
Ref. D0RI3900



BRAKE LIGHT
Ref. D0B40KL



LED

No cover top case Ref. D0B39100
Carbon cover top case Ref. D0B39106
COLOUR COVERS
Ref. D1B39E...

-  08-White
-  15-New titanium
-  21-Black
-  Unpainted cover
Ref. D1B39ER

SH37

X40 Y49 Z31 (cm)
Ref. D0B37100+D1B37E08



SH34

X42 Y43 Z31 (cm)
Ref. D0B34106



FEATURES



Icons description Page 130

INCLUDED

STANDARD PLATE



ACCESSORIES

BACKREST
Ref. D0RI60









BRAKE LIGHT
Ref. D0B29KL

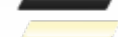

LED

No cover top case Ref. D0B37100
COLOUR COVERS
Ref. D1B37E...

-  01-Blue
-  05-Silver
-  08-White
-  09-Red
-  21-Black
-  Unpainted cover
Ref. D1B37ER

FEATURES



Icons description Page 130

INCLUDED

STANDARD PLATE



ACCESSORIES

BACKREST
Ref. D0RI40



BRAKE LIGHT
Ref. D0B29KL



LED

SH33

X42 Y43 Z31 (cm)
Ref. D0B33200+D1B33E21



SH29

X38 Y40 Z30 (cm)
Ref. D0B29100+D1B29E05



FEATURES



Icons description Page 130

INCLUDED

STANDARD PLATE



ACCESSORIES

BACKREST
Ref. D0RI40









BRAKE LIGHT
Ref. D0B29KL



LED

No cover top case Ref. D0B33200
COLOUR COVERS
Ref. D1B33E8...

-  01-Blue
-  08-White
-  09-Red
-  15-New titanium
-  21-Black
-  Unpainted cover
Ref. D1B332ER

FEATURES



Icons description Page 130

INCLUDED

STANDARD PLATE



ACCESSORIES

BACKREST
Ref. D0RI40







BRAKE LIGHT
Ref. D0B29KL



LED

No cover top case Ref. D0B29100
COVER COLOURS
Ref. D1B29E...

-  01-Blue
-  08-White
-  09-Red
-  21-Black
-  Unpainted cover
Ref. D1B29ER

SH26

X40.5 Y40 Z28.2 (cm)
Ref. D0B26100



FEATURES



Icons description Page 130

INCLUDED

STANDARD PLATE



ACCESSORIES

BRAKE LIGHT
Ref. D0B29KL



LED

SIDE CASES



reddot design award
winner 2017



GERMAN
DESIGN
AWARD
SPECIAL
2017



SH35

X51 Y30 Z38 (cm)
Ref. D0B35200



Retractable handle
Elastic strap
Structural frame
Inner tray



FEATURES



Icons description Page 130

INCLUDED

EXTRA LOCK FOR YOUR TOP CASE



PREMIUM LOCK - 1 HAND USE



ACCESSORIES

INNER BAG
Ref. X0IB36



X 28 Y 41 Z 31 (cm)

SIDE FITTING



PATENTED



+ info Page 97



+ info Page 96



SH36

X51 Y33 Z38 (cm)
The lightest in its range
Ref. D0B36200



reddot design award
winner 2015



THE MOST DESIGN-AWARDED
SIDE CASES SH36



Modular Helmet XXL
Retractable Handle
Elastic strap
Structural frame
Inner tray



CARBON
Ref. D0B36200



WHITE
Ref. D0B36200+D1B36E08



NEW TITANIUM
Ref. D0B36200+D1B36E15



BLACK METAL
Ref. D0B36200+D1B36E21



FEATURES



Icons description Page 130

INCLUDED

EXTRA LOCK FOR YOUR TOP CASE



PREMIUM
LOCK - 1 HAND USE



INNER BAG
Ref. X0IB36



X 28 Y 41 Z 31 (cm)

ACCESSORIES

RED REFLECTION
Ref. D1B36CAR



SIDE FITTING



PATENTED



+ info Page 97



+ info Page 96



SH23

X49 Y26 Z35 (cm)
Ref. D0B23100+D1B23E08



BLACK
Ref. D0B23100

WHITE
Ref. D0B23100 +
D1B23E08

NEW TITANIUM
Ref. D0B23100 +
D1B23E15

ALU LOOK COVER
INCLUDED
Ref. D0B23200W



FEATURES



Icons description Page 130

INCLUDED

EXTRA LOCK FOR YOUR TOP CASE



SIDE FITTING



PATENTED



+ info Page 97

ACCESSORIES FOR CASES

BACKRESTS



INNER BAGS

Ref. X0IB47 → EXPANDABLE



Ref. X0IB00



Ref. X0IB10 → EXPANDABLE



Ref. X0IB36



UPPER RACK



COLOUR COVERS



BRAKE LIGHTS

Ref. D0B40KL



Ref. D0B29KL



INNER MESH

Ref. X0TR01



TOP CASES

| | Backrest | Inner bags | Upper rack | Brake lights | Colour covers* |
|-------------------|----------|------------|------------|--------------|----------------|
| TR37/TR37B | D0RI75 | X0IB47 | | | |
| TR48/TR48B | D0RI75 | X0IB47 | | | |
| SH59X | D0RI80 | X0IB10 | | D0B29KL | |
| SH58X | D0RI80 | X0IB10 | | D0B29KL | ■ ■ ■ |
| SH50 | INCLUDED | X0IB00 | D0PS00 | D0B29KL | ■ ■ ■ ■ ■ ■ |
| SH48 Dark Grey | D0RI4800 | X0IB00 | D0PS00 | D0B29KL | ■ ■ ■ ■ ■ |
| SH48 New Titanium | D0RI4800 | X0IB00 | D0PS00 | D0B29KL | ■ ■ ■ ■ ■ |
| SH47 Red | D0RI47 | X0IB00 | | D0B40KL | ■ ■ ■ ■ ■ |
| SH47 White | D0RI47 | X0IB00 | | D0B40KL | ■ ■ ■ ■ ■ |
| SH46 | D0RI50 | X0IB00 | D0PS00 | D0B40KL | ■ ■ ■ ■ ■ |
| SH45 | D0RI60 | X0IB00 | | D0B40KL | ■ ■ ■ ■ ■ |
| SH44 | D0RI60 | X0IB00 | | D0B40KL | ■ ■ ■ ■ ■ |
| SH40 | D0RI60 | | | D0B40KL | ■ ■ ■ ■ ■ |
| SH40 CARGO | D0RI60 | | | D0B40KL | ■ ■ ■ ■ ■ |
| SH39 | D0RI3900 | | | D0B40KL | ■ ■ ■ ■ ■ |
| SH37 | D0RI60 | | | D0B29KL | ■ ■ ■ ■ ■ |
| SH34 | D0RI40 | | | D0B29KL | ■ ■ ■ ■ ■ |
| SH33 | D0RI40 | | | D0B29KL | ■ ■ ■ ■ ■ |
| SH29 | D0RI40 | | | D0B29KL | ■ ■ ■ ■ ■ |
| SH26 | | | | D0B29KL | ■ ■ ■ ■ ■ |

SIDE CASES

| | INNER BAGS | INNER MESH | COLOUR COVERS* |
|------------|------------|------------|----------------|
| TR36/TR36B | X0IB47 | X0TR01 | |
| TR47/TR47B | X0IB47 | X0TR01 | |
| SH36 | X0IB36 | | ■ ■ ■ ■ ■ |
| SH35 | X0IB36 | | ■ ■ ■ ■ ■ |
| SH23 | | | ■ ■ ■ ■ ■ |

* PLEASE CHECK EVERY CASE CATALOGUE PAGE TO SEE REFERENCES

■ Blue ■ Silver ■ Carbon ■ White ■ Red ■ New titanium ■ Dark Grey ■ Black ■ Non painted cover



FITTING KITS

TOP CASES



SIDE CASES



SIDE BAG HOLDER



SIDE BAG HOLDER SR



BAGS / OTHERS

BIKE COMPATIBILITY



BACKRESTS



Scooter



Custom

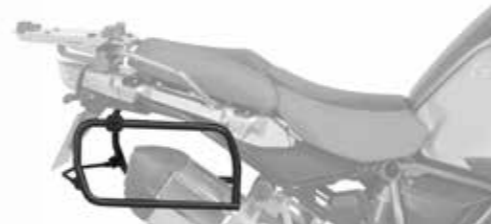

BIKE COMPATIBILITY



DURABILITY
Designed for hard use. Transversal support to increase strength between the two cases.

MATERIAL
20mm Steel frame. Biggest in the market. Metallic powder coated paint.

COMPATIBLE WITH: TR47L & TR47R, TR47L & TR47R BLACK EDITION, TR36L & TR36R, TR36L & TR36R BLACK EDITION, SH36, SH35.

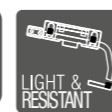

PATENTED

INTEGRATED DESIGN
Close fit and minimize the aesthetic change of the bike

LIGHTNESS
Nearly no change in the bike's center of gravity, hence improving safety.

COMPATIBLE WITH: SH36, SH35, SH23



MATERIAL
20mm Steel frame. Biggest in the market. Metallic powder coated paint.

PATENTED
3 point to fit the case on the bike.

TOP FITTING

TOP MASTER

Bike compatibility



PIN SYSTEM

QUICK FITTING TANK BAGS



PLATES



S

Small Rack
(INCLUDED)
SH26/SH29/SH33/SH34

M

Medium Rack
(INCLUDED)
SH39/SH40/SH44/SH45/
SH46/SH47

B

Big Rack
SH59X/SH58X/SH50/SH48
(INCLUDED)
TR48/TR37 (not INCLUDED).-
D1B59PA

A

Aluminium Racks
(not included)
SH59X/SH58X/SH48/TR48/
TR37
Aluminium Rack.- D1BTRPA
Black Aluminium Rack.-
D1TRPA2

SIDE BAG HOLDER

Side Bag Holder:
SL58/SE48/SW42



Universal side holder
SL58/SE48/SW42
Ref. D0SS5E



SR Side Bag Holder:
SL58/SE48/SE48SR/SR38



PATENT PENDING

BACKRESTS

SCOOTER

STEP 1. Backrest
Choose your favorite color

STEP 2: Fitting kit
Look for your motorcycle model

Ref. D0RP00

Ref. D0RP08

Ref. D0RP05

Ref. D0RP00N



CUSTOM SISSYBAR

STEP 1.
Backrest



STEP 2.
Top case Rack



Chromed
ref. NADTN

Black
ref. NADTNN



COMFORT SEATS

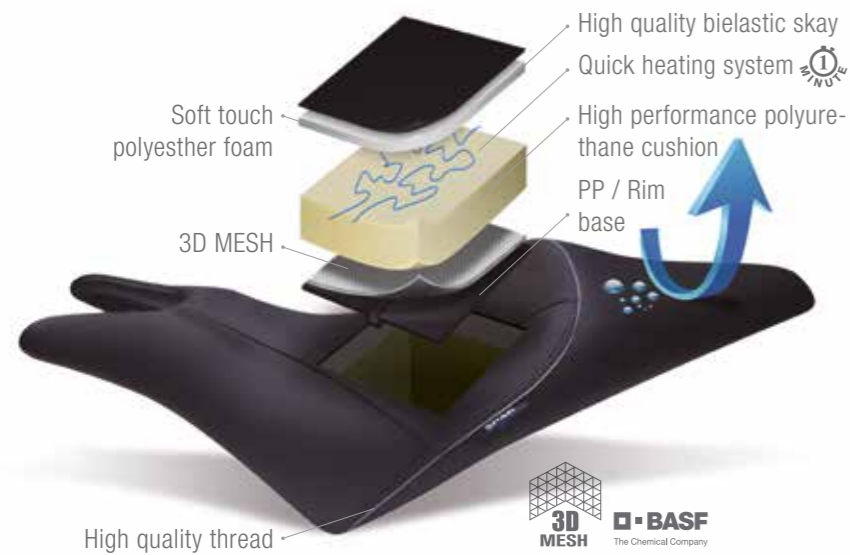

SHAD
style

High quality bielastic skay
Resistant to:



YAMAHA T-MAX

Model and year

T-MAX 500 (2008-13)
T-MAX 530 (2014-16)



Ref. SHY0T5320
Black, with white seams



KAWASAKI Z750-1000

Model and year

Z750 (2007-13)
Z1000 (2007-09)



Ref. SHK0Z1000C
Black, with dark, grey seams

YAMAHA FZ6

Model and year

FAZER FZ6 600 (2004-10)



Ref. SHY0F7000
Black, with grey seams



PIAGGIO MP3

Model and year

MP3 RL (2007-12)
MP3 RST 125-250-100 (2009-12)
MP3 LT 250-400 (2009-13)
MP3 500 SPORT/BUSINESS (2011-13)



Ref. SHV0M2320
Black-white, grey-blue seams

YAMAHA MT-09

Model and year

MT-09 (2013-18)



Ref. SHY0M9300
Black-grey, with grey seams



BAGS



SPORT



TOURING



PIN SYSTEM



CAFE RACER



Genuine

ADVENTURE

100%

WATERPROOF

SPORT & TOURING



SR SIDE BAG HOLDER
SAFETY LOCK WITH KEY
+ info Page 98



CHECK FOR MOTORCYCLE
SPECIFIC FITTING KIT
www.shad.es

NEW E48SR HARD SHELL SADDLE BAGS

X 45 Y 27 Z 29 (cm)
Ref. X0SE48SR



Secure

Locking mechanism secures the case to the bike. Combination locks access to the inside.



Fast

Remove or place the bag on the bike instantly and turn the key. 3 seconds install.



Inner features

Inner bag, compression straps, zippered mesh cover on lid, cushioned inner liner, double reinforced hinges.



Design

Designed in Barcelona: Aerodynamic 3D body, red accent pieces are integrated carrying handles.



Water resistance

Outer hardshell and inner bag ensures waterproofness.



NEW E48

EXPANDABLE SADDLE BAGS

X 47 Y 24/30 Z 29 (cm)
Ref. X0SE481



SIDE BAG HOLDER
+ info Page 98

NEW SL58

EXPANDABLE SADDLE BAGS

X47 Y18/21 Z29 (cm)
Ref. X0SL58



SIDE BAG HOLDER
+ info Page 98

Accessories (pag. 117)

E04

SMALL TANK BAG

X29 Y26 Z10 (cm)
Ref. X0SE04



Accessories (pag. 117)

SL20F

TANK BAG

X40 Y30 Z18/21 (cm)
Ref. X0SL20F



Accessories (pag. 117)

SL12M

SMALL TANK BAG

X30 Y19 Z10 (cm)
Ref. X0SL12M



Accessories (pag. 117)

SC25

SCOOTER BAG

X38 Y27 Z26 (cm)
Ref. X0SC25



SL04

SMALL LEG BAG

X3 Y26 Z13 (cm)
Ref. X0SL04



SL86

BACKPACK

X30 Y27 Z45 (cm)
Ref. X0SL86



SL03

WAIST BAG

X9 Y23 Z16 (cm)
Ref. X0SL03



SL05

BIG LEG BAG

X11 Y25 Z15 (cm)
Ref. X0SL05



SL01

TOLL PASS POUCH

X4 Y6 Z10 (cm)
Ref. X0SL01



BAGS



PATENT PENDING

STEP 1. Choose your bag

E04P

Ref. X0SE04P



E10P

Ref. X0SE10P



E16P

Ref. X0SE16P



STEP 2. Fit to your bike



4 POSITIONS

4 Positions to adapt to your bike
E-10P / E-16P



Bike compatibility



E16P TANK BAG

X40 Y28 Z20/26 (cm)
Ref. X0SE16P



E10P TANK BAG

X31 Y22 Z15 (cm)
Ref. X0SE10P



E04P SMALL TANK BAG

X30 Y21 Z11 (cm)
Ref. X0SE04P



Accessories (pag. 117)

CAFE RACER
SHAD
 ENGINEERED FOR RIDING
SR
Genuine
 SINCE 1973
 INSPIRED IN BARCELONA
 WWW.SHAD.ES



FEATURES



SR28
 TAIL BAG
 Ref. X0SR28

SR18
 TANK BAG
 Ref. X0SR18

SR38
 SADDLE BAG
 Ref. X0SR38

SR18
 TANK BAG
 X36 Y18 Z15(cm)
 Ref. X0SR18



SR28
 TAIL BAG
 X25 Y40 Z26(cm)
 Ref. X0SR28



SR38
 SADDLE BAG
 X24 Y15 Z34 (cm)
 Ref. X0SR38



SAFETY LOCK WITH KEYS



CHECK FOR MOTORCYCLE SPECIFIC FITTING KIT www.shad.es



100% **WATERPROOF**

-  HIGH QUALITY
-  EXTREME TEMPERATURES
-  HIGH RESISTANCE
-  UV PROTECTION



FEATURES



- SW 42**
SADDLE BAGS
- SW 38**
DUFFLE REAR BAG
- SW 22**
MAGNETIC TANK BAG
- SW 45**
REAR BAG
- SW 23**
TANK BAG



- REF: X0SW42
SADDLE BAGS SW42
- REF: X0SW38
REAR DUFFLE SW38
- REF: X0SW22
TANK BAG SW22
- REF: X0SW45
REAR BAG SW45
- REF: X0SW23B
TANK BAG SW23B

ADVENTURE BAGS

100%
WATERPROOF
SEAMLESS
HIGH FREQUENCY WELDING

PVC TARPULIN
3 LAYERS



ROLL CLOSURE



IPX5

QUICK FITTING
EASY TO FIX

FAST



FAST



EXTRALOAD
Molle System



EXTRA STORAGE FLAP



SW42
SADDLE BAGS
X42 Y17 Z34 (cm)
Ref. X0SW42



Accessories (pag. 117)

100% WATERPROOF

 SIDE BAG HOLDER



 CHECK FOR MOTORCYCLE
SPECIFIC FITTING KIT
www.shad.es

+ info Page 98

SW23B

TANK BAG

X35 Y26 Z24 (cm)
Ref. X0SW23B



100% WATERPROOF



SW22

TANK BAG

X37 Y19 Z16 (cm)
Ref. X0SW22



IB20

REAR BAG

0 25,5 Z53,5 (cm)
Ref. X0IB20



SW45

REAR BAG

X31 Y48 Z17 (cm)
Ref. X0SW45



ACCESSORIES FOR BAGS

MAGNETS (4U.)

Ref. X1SL11

FOR:

SL20F
SL12M
E22
E04
SW23B



STRAPS

Ref. X1SL09

FOR:

SL20F



RAIN COVER

Ref. X1SL01

FOR:

E04
SL12M
E04P

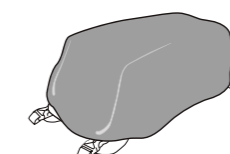

FILM PROTECTOR

Ref. X1SL02

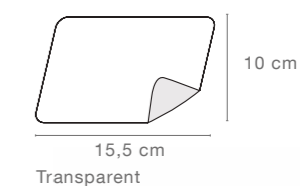

SW38

REAR DUFFLE BAG

X28 Y54 Z28 (cm)
Ref. X0SW38



UNIVERSAL BASE TANK

Ref. X1SL90

FOR:

E22
E04
SL20F
SL12M



DUFFLE BAG

Ref. X0IB08



THERMO PAD

Ref. X1SB97

FOR:

E48
SE48SR
SL58
SW42



SMARTPHONE HOLDERS



MIRROR AND HANDLEBAR SYSTEM



SHAD ENGINEERED MOUNTING SYSTEM

HANDLEBAR SIZES

GLOVE FRIENDLY

SECURITY STRAP



360° SUPPORT

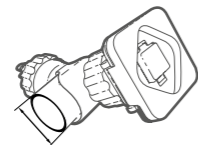

20-40 MM



QUICK CLICK SYSTEM

SMARTPHONE CASE

X-FRAME SYSTEM



- 1 LIGHT RAIN RESISTANT CASE
- 2 CABLE OUTLET
- 3 TOUCH SCREEN

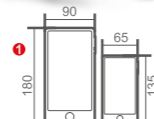

- 1 PHONE SIZES
- 2 SAFETY TETHER
- 3 RUBBER GRIPS
- 4 DESK SUPPORT

X-FRAME

HANDLEBAR HOLDER

MIRROR HOLDER



MAX. PHONE SIZE

180x90 mm

Ref. X0SG00H

Ref. X0SG00M

SMARTPHONE HOLDERS WITH POCKET

HANDLEBAR HOLDER

MIRROR HOLDER



MAX. PHONE SIZE

180x90 mm

Ref. X0SG76H

Ref. X0SG76M

SMARTPHONE HOLDERS

HANDLEBAR HOLDER

MIRROR HOLDER



MAX. PHONE SIZE

160x80 mm

Ref. X0SG62H

Ref. X0SG62M

180x90 mm

Ref. X0SG71H

Ref. X0SG71M

RAIN JACKET



| Size | cm | Ref. |
|------|------|-----------|
| S | 57 | X0SR55S |
| M | 59.5 | X0SR55M |
| L | 62 | X0SR55L |
| XL | 64.5 | X0SR55XL |
| XXL | 67 | X0SR55XXL |
| 3XL | 69.5 | X0SR553XL |

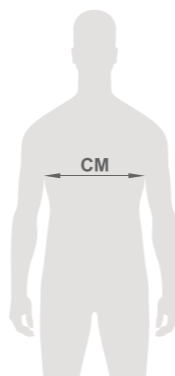

HAND MUFFS

X36.5 Y26 Z50 (cm)
Ref. X0SR00

Quick Fitting

Fur lining

Adaptable to a majority of motorcycles



RAIN PANTS



| Size | cm | Ref. |
|------|------|-----------|
| S | 34 | X0SR20S |
| M | 36.5 | X0SR20M |
| L | 39 | X0SR20L |
| XL | 41.5 | X0SR20XL |
| XXL | 44 | X0SR20XXL |
| 3XL | 46.5 | X0SR203XL |

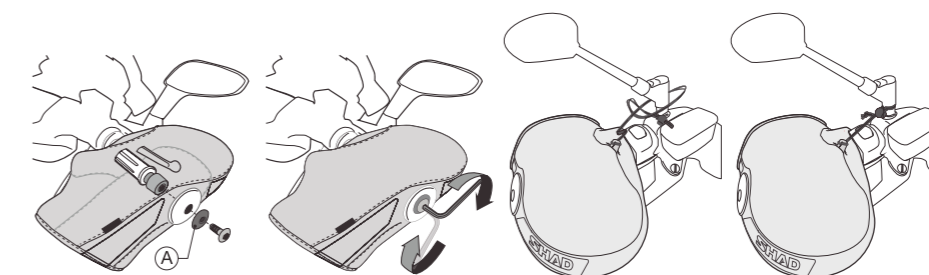
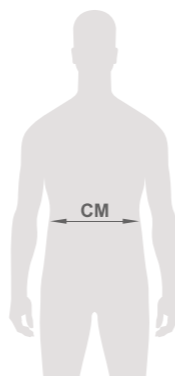

ATV CASES



ATV110

X58.5 Y93 Z34 (cm)
Ref. D0Q1100



X55 Y90 Z26 (cm)
Ref. S0Q800



ATV40

X37 Y74 Z19 (cm)
Ref. D0Q200





FEATURES



PATENT PENDING

- 1 Premium lock cylinder up to 30.000 cycles
- 2 Reversible premium key with more than 10.000 keys combinations
- 3 The head set can rotate 360°
- 4 All components satisfy the REACH environmental Regulation
- 5 Side use of the cylinder lock: more comfortable and great water resistance
- 6 Cylinder lock fitting is inaccessible
- 7 Invisible assembly between the head set and the chain
- 8 Logo and other graphics are pad printed

SERIE 3



SC 307H
Ref. C0S307H



49 cm

SC 305H
Ref. C0S305H



44 cm

SC 303H
Ref. C0S303H



38 cm

SERIE 2



SC 207H
Ref. C0S207H



49 cm

SC 205H
Ref. C0S205H



44 cm

SC 203H
Ref. C0S203H



38 cm

- 1 Premium lock cylinder up to 30.000 cycles
- 2 Reversible premium key with more than 10.000 keys combinations
- 3 The head set can rotate 360°
- 4 All components satisfy the REACH environmental Regulation

FULLY EQUIPPED MOTORCYCLES

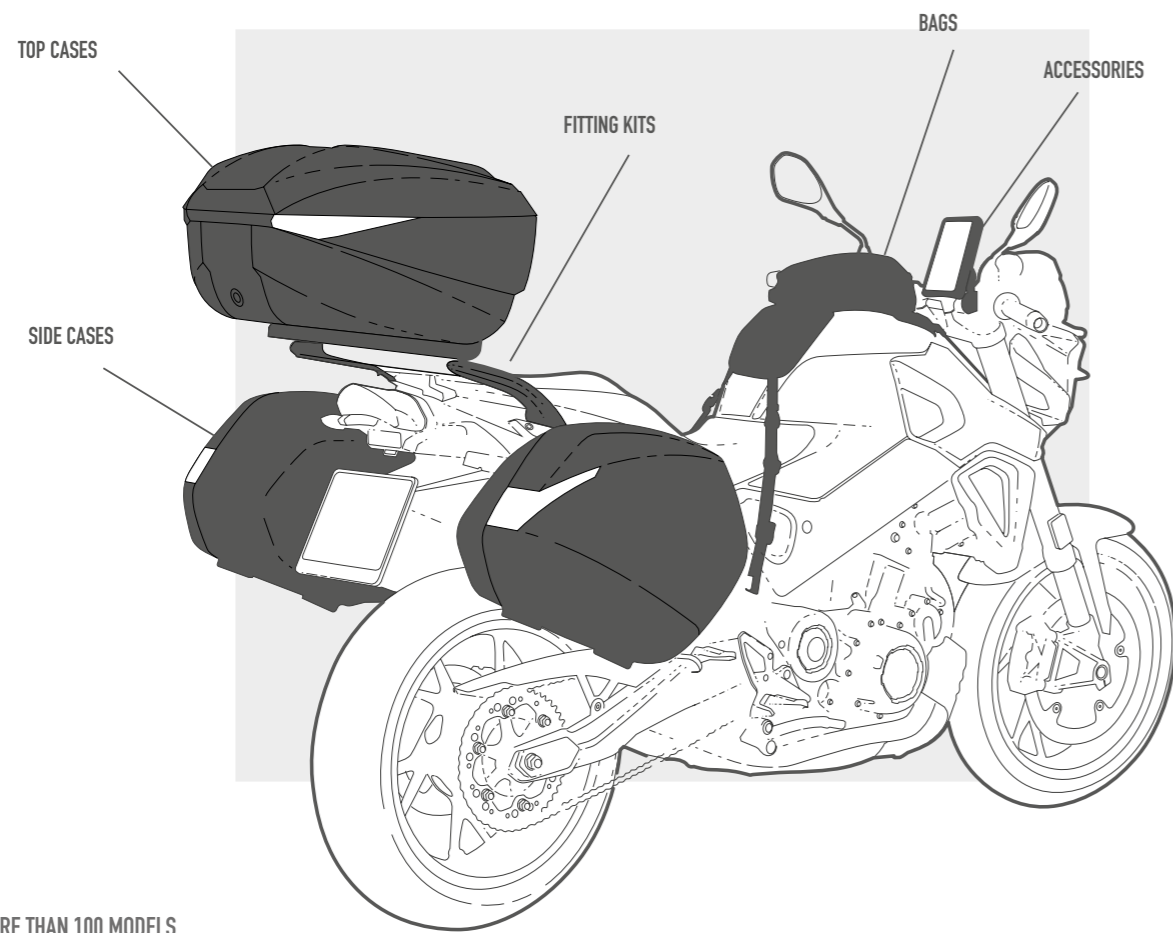

MORE THAN 100 MODELS



CHECK OUR FULLY EQUIPPED CATALOGUES:



SPARE PARTS

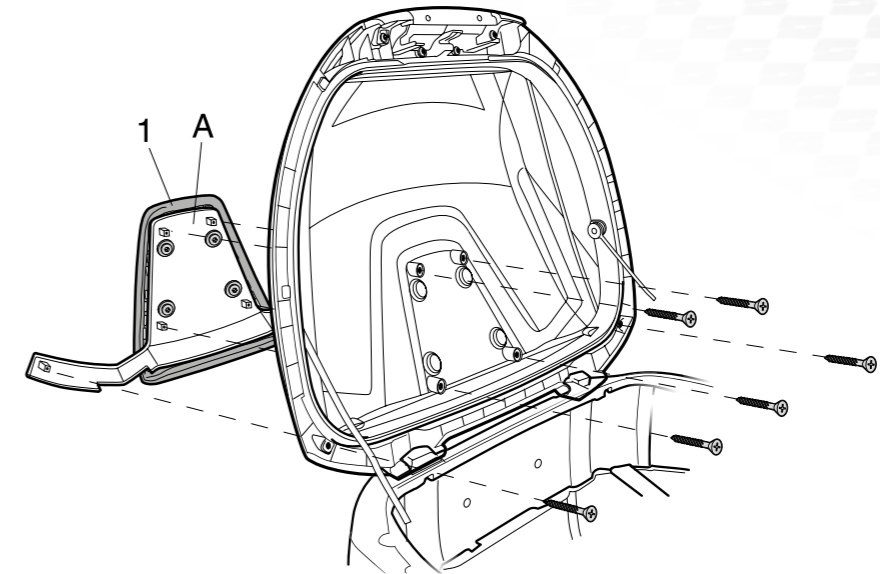

DOWNLOAD OUR SPARE PARTS CATALOGUE



YOUTUBE SUPPORT CHANNEL:
TECHNICAL INFO
SPARE PARTS INSTALLATION
ACCESSORIES MOUNTING GUIDE

SHAD SUPPORT

TOP CASES



SIDE CASES



BAGS



FITTING KITS

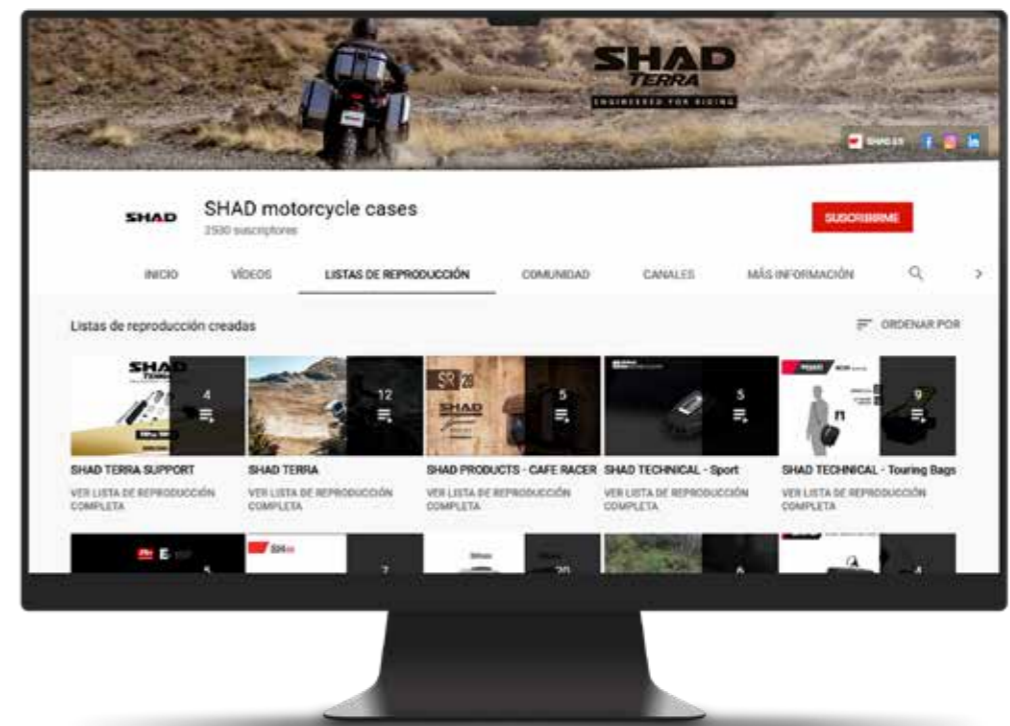

DISPLAYS

9 TOP CASES

REF. D0EX03 (1u.) + D0EX02 (2u.) + D0EX10 (1u.)



SH36/SH35/SH23 DISPLAY

Ref. D0EX201

TERRA DISPLAY

Ref. D0TR201



PIN SYSTEM DISPLAYS

FLOOR STAND: Ref. D0EXPS01

SINGLE TOP CASE DISPLAY

SLATWALL: Ref. D0EXTRR



WALL: Ref. D0EXTRP

RIGHT SIDE WALL DISPLAY

4P SYSTEM: Ref. D0EXP04P



3P SYSTEM: Ref. D0EXPIF



SADDLE BAGS DISPLAY

SR38/SL58/E48/E48SR

WALL: Ref. D0EX19SR



FOR ALL TOP CASES. WITH FLOOR STAND

Ref. D0EX23



3 TOP CASES

Ref. D0EX02



BIG TOP CASES

SH59X-SH58X-SH50-SH49-SH48

Ref. D0EX10



D0EX58



D0EX201

TABLE TOP:

REF. D0EXPS031:
DISPLAY + BAG E04P



ICONS DESCRIPTION



Expandable case



2 flip-up helmets



2 full face helmets



2 helmets: full face and jet



Waterproof IPX5



Handlebar bracket



Mirror Bracket



Safety lock



2 Trail helmets



2 helmets: flip-up and jet



1 flip-up helmet



1 full face helmet



SR Side Bag Holder



Clean



Quick assembly



Practical



1 jet helmet



Maximum load



Secure lock system



SHAD change colour system



Secure



EU Design



Compression straps



Backrest



Inner bag



Upper rack



Light



Inner tray



Capacity



Reflector



Waterproof



Side Bag Holder



Aluminium Mounting Plate



Semi rigid



CATALOGUE LANGUAGES:
Find your translation scanning this QR Code.



NAD

SHAD NETWORK:

SHAD WORLD (BARCELONA)

Octave Lecante 2-6
Pol. Ind. Can Magarola
08100 Mollet del Vallès · Barcelona · Spain
Tel. +34 935 795 866
NAD Clients Tel.: +34 935 795 860
Fax: +34 935 796 945

SHAD ESPAÑA

Teléfono: +34 935 795 870

SHAD FRANCE

Téléphone: +34 935 795 868

SHAD ITALY

Telefono: +34 935 795 867

SHAD USA

19096 NE 4th Court
Miami FL, 33179
USA

SHAD CHINA

士雅的摩托车配件（上海）有限公司
SHAD MOTORCYCLE ACCESSORY
(SHANGHAI) COMPANY LTD.
地址：闵行区泰虹路268弄1号万科时
一区T3栋501室

SHAD INDONESIA

Jl. Kemang Selatan VIII No.56 Unit B
Jakarta 12730 Indonesia
T: (+62) 212271 8560

info@shad.es

WWW.SHAD.ES



Code: 999326 Ed. 1



ISO 9001
ISO 14001
BUREAU VERITAS
Certification

